

# WYNDHAM COLLECTION

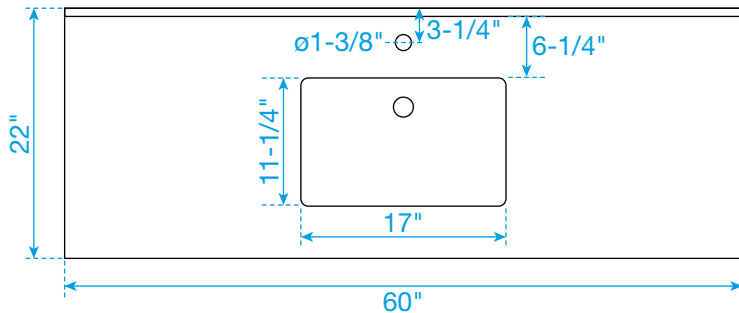

TOP VIEW OF VANITY CABINET

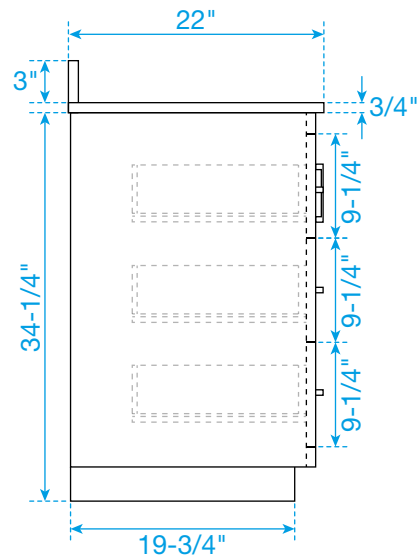
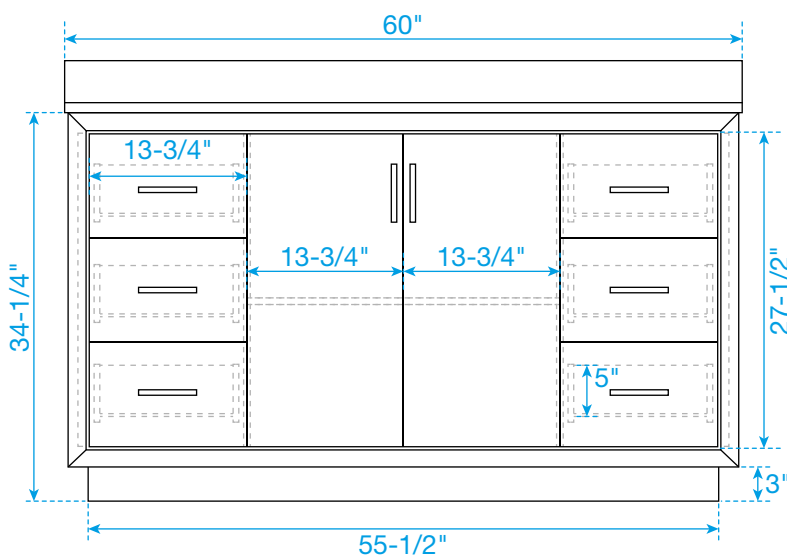
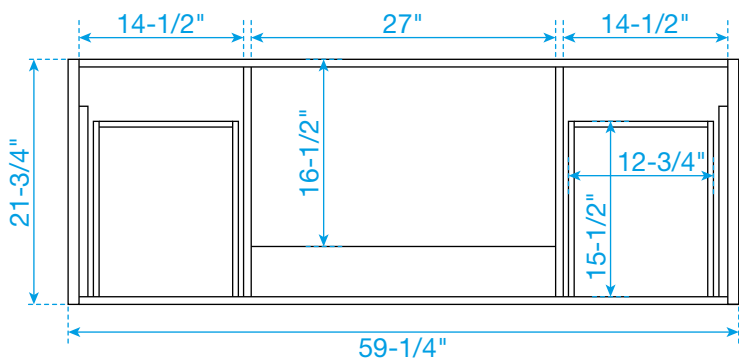
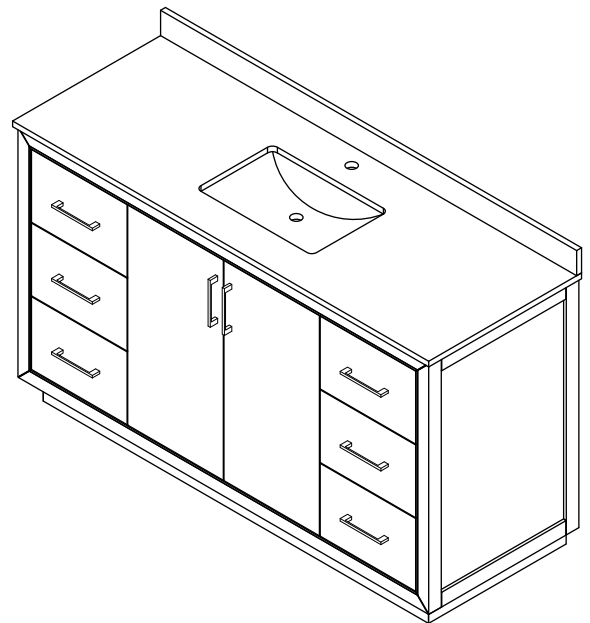

\*Note: Due to high probability of breakage, the backsplash comes in two pieces, cut from the same piece. All measurements are  $\pm 1/4"$ .

## WC-1111-60-SGL

# WYNDHAM COLLECTION

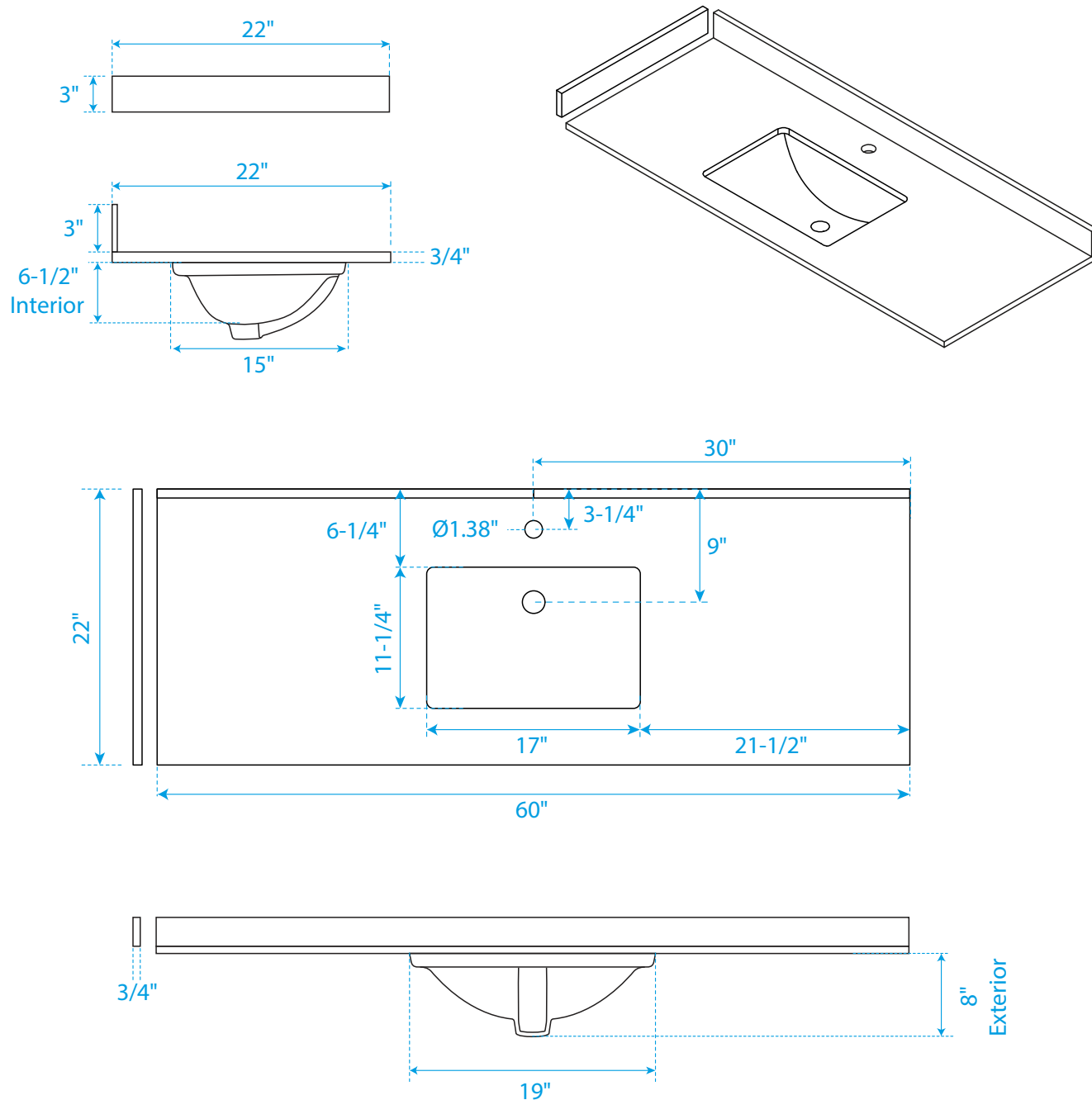

Side splash is reversible.

Note: Due to high probability of breakage, the backsplash comes in two pieces, cut from the same piece. All measurements are  $\pm 1/4"$ .

WC-VCA-60-SGL-TOP