

WYNDHAM COLLECTION

SKU - WC-BTK1504-59
Exterior Size - 59"L x 29-1/2"W x 22-5/8"H
Depth at Drain - 18-1/2"
Note - All measurements are $\pm 1/2$ "

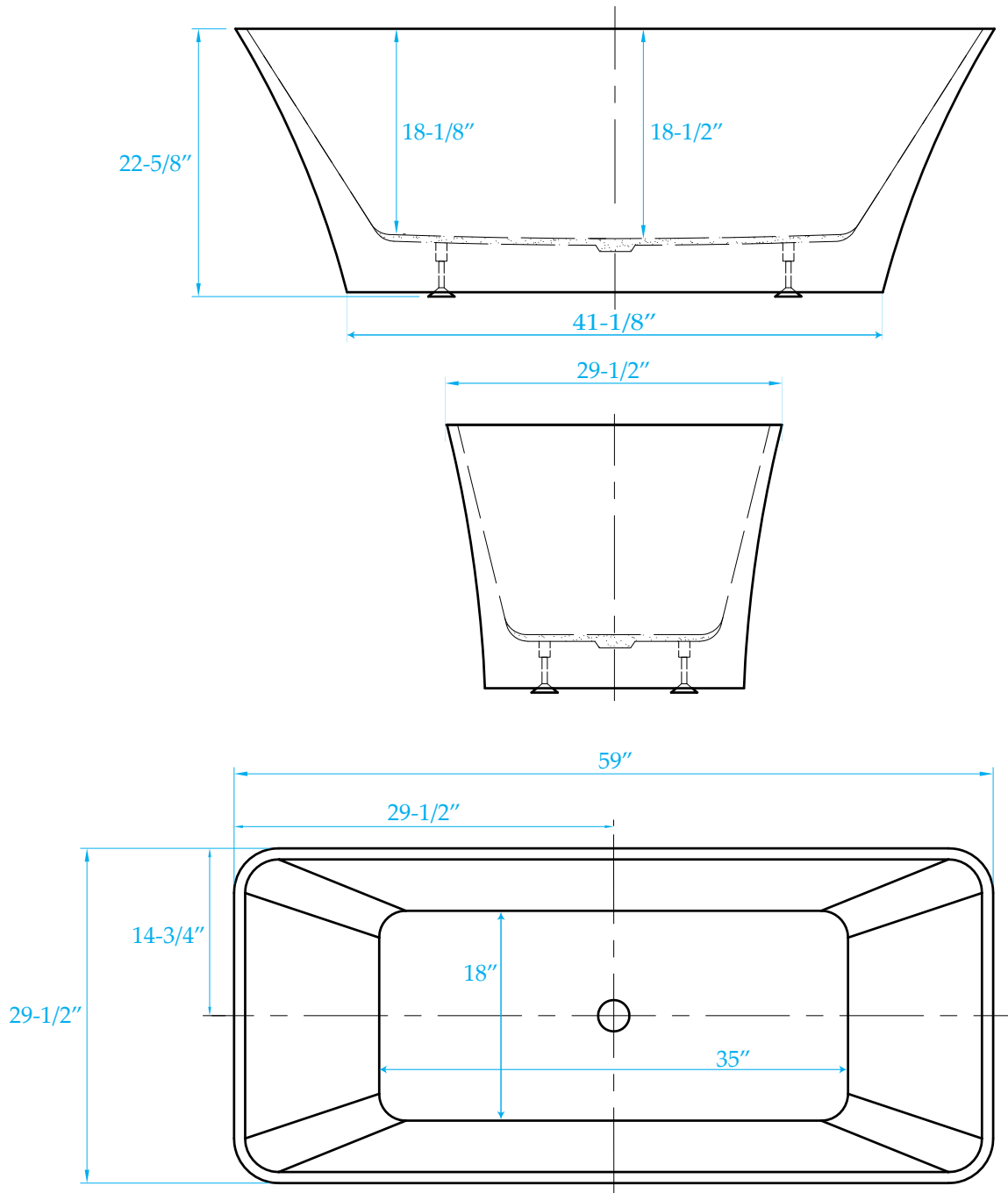

WC-BTK1504-59