

**INSTALLATION MANUAL
FOR MODELS: TERAZZA,
TRACCIO, MILANO,
CERRATO**

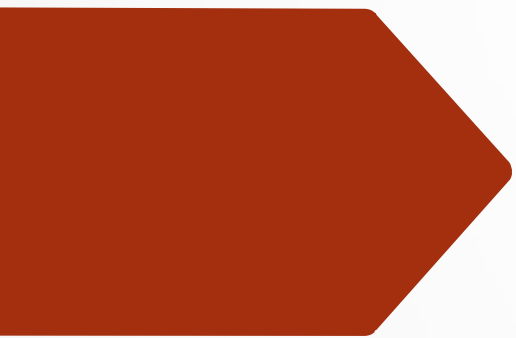

TABLE OF CONTENTS

ROOM SPECIFICATIONS

ELECTRICAL SPECIFICATIONS

PLUMBING SPECIFICATIONS

TECHNICAL SPECIFICATIONS

INTRODUCTION

ASSEMBLY AND PLANNING

CONNECTING ELECTRIC TO THE HOMES MAIN CIRCUITS

SOME NOTES NOT TO FORGET

POWER REQUIREMENTS

TOOLS NEEDED TO GET THE JOB DONE

CRATE CONTENTS

CRATE# 1 (the large one)

CRATE# 2 (the smaller one)

WATER PRESSURE REQUIREMENT

WATER GALLONS PER MINUTE (GPM) REQUIREMENT

PACKING LIST

BEGIN INSTALLATION

STEP ONE

STEP TWO

STEP THREE

STEP FOUR

STEP FIVE

STEP SIX

STEP SEVEN

STEP EIGHT

STEP NINE

STEP TEN

STEP ELEVEN

STEP TWELVE

NOTE 1

SEALANT INSTRUCTIONS

CLOSING

DIMENSIONS

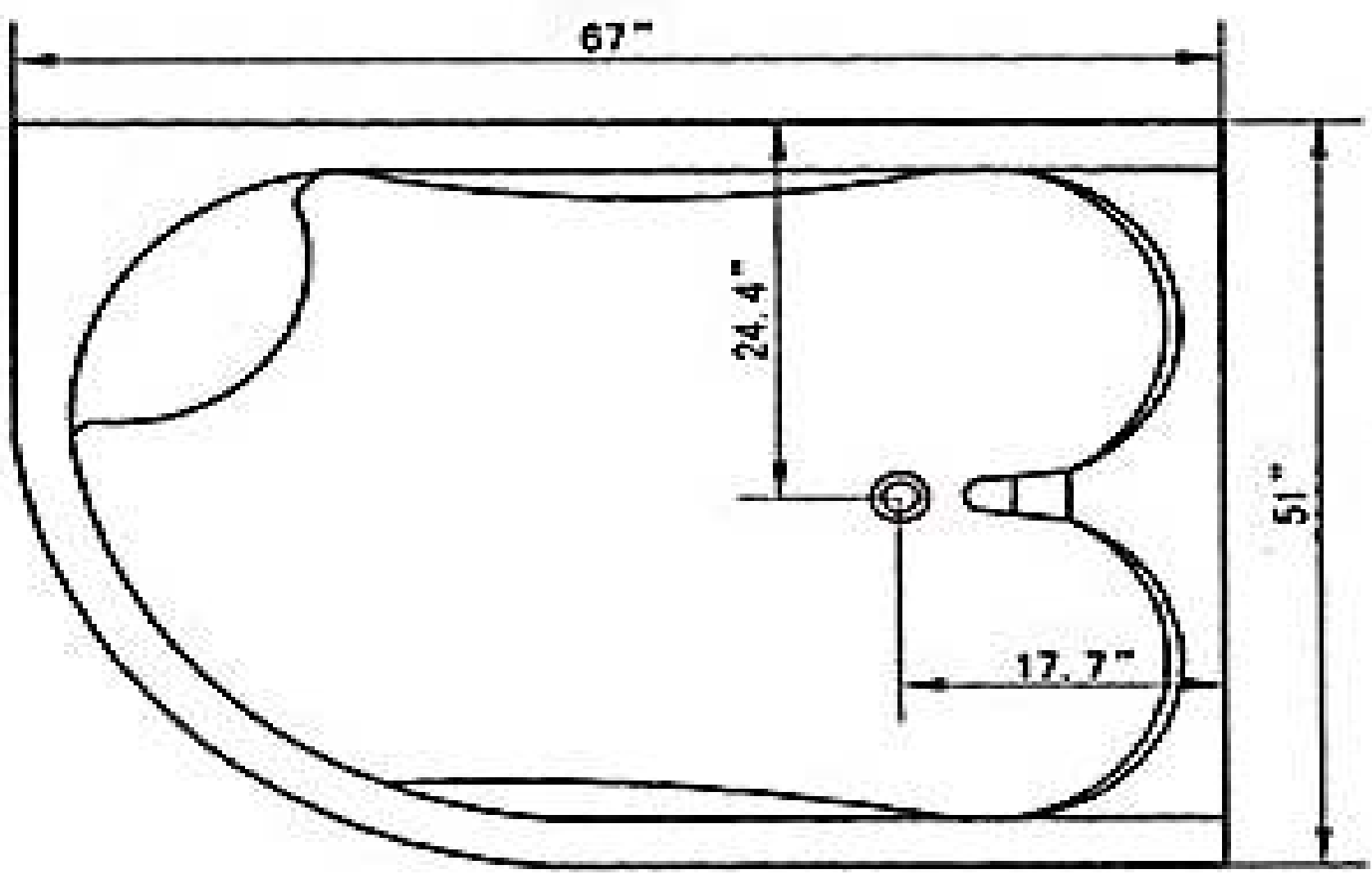
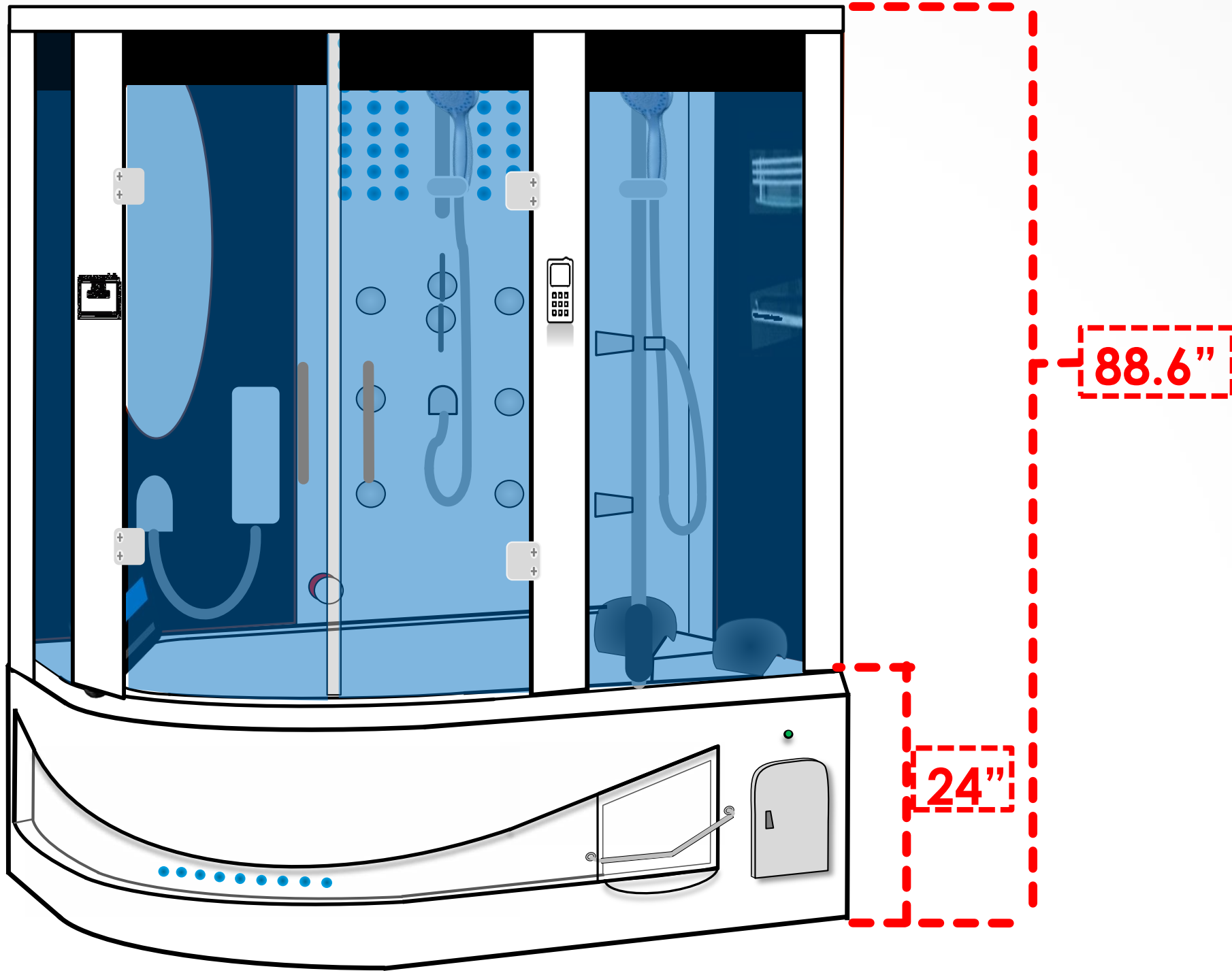

TERRAZA, TRACCIO, MILANO, CERRATO STEAM SHOWER UNIT DIMENSIONS

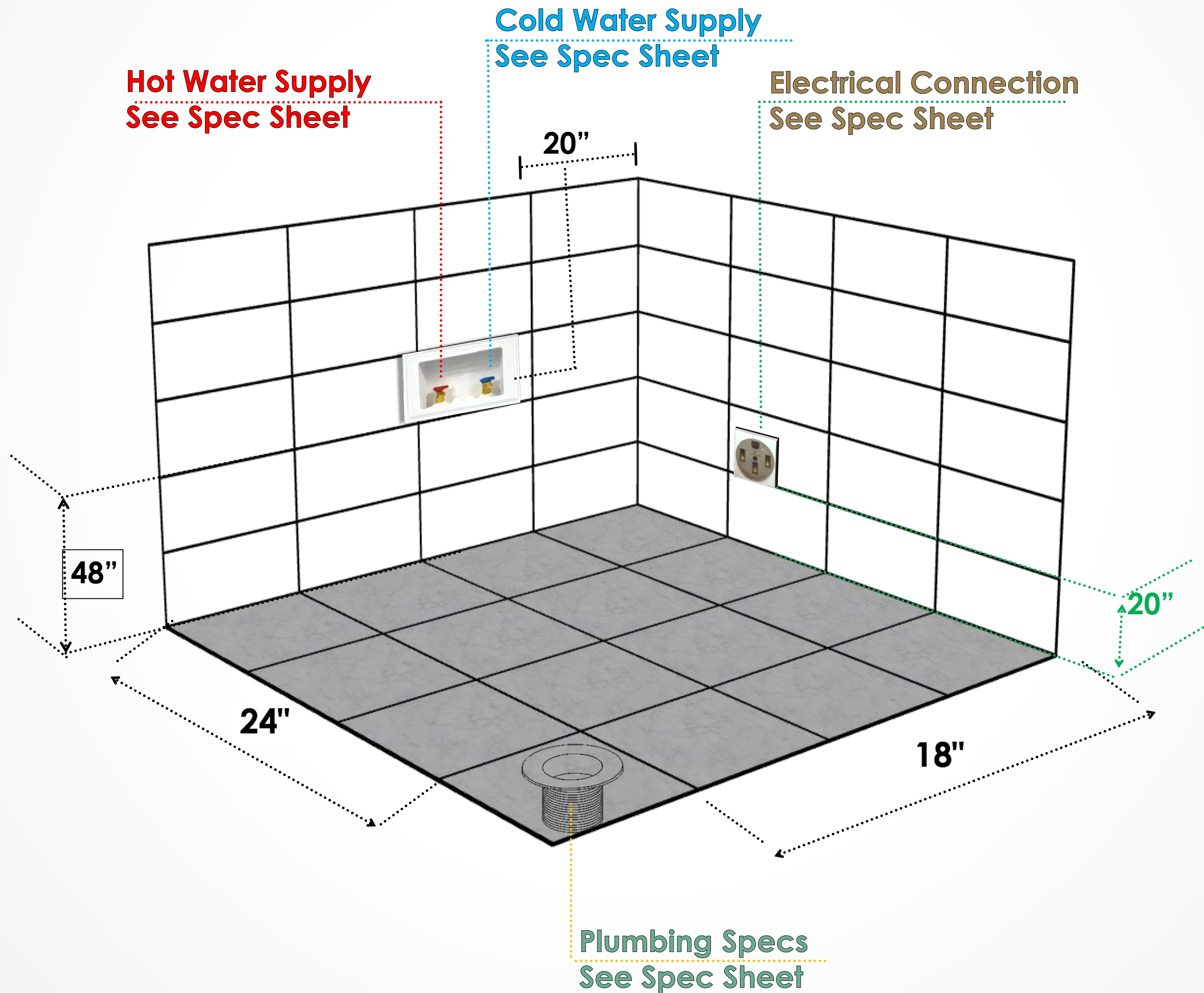

ASSEMBLY AND SIMPLE PLUMBING

THIS PRODUCT BUILD IS RATED SUITABLE FOR DIY PURPOSES PROVIDING (YOU) THE CUSTOMER HAS AVERAGE KIT BUILDING SKILLS AND FEEL CONFIDENT IN YOUR ABILITY. ONLY YOU WILL KNOW THIS SO BEFORE ANY ATTEMPT IS MADE TO ASSEMBLE, READ THROUGH THE FOLLOWING PAGES IN DETAIL, THEN DECIDE IF YOU FEEL COMFORTABLE COMPLETING THIS INSTALL. IF YOU HAVE ANY DOUBT, USE THE SERVICES OF A PROFESSIONAL. IN PICKING SUCH, ENSURE THEY ARE CAPABLE OF INSTALLATION BY PROVIDING THESE INSTRUCTIONS TO THEM. ALWAYS GET THREE QUOTES.

REMEMBER THE BEST IS NOT ALWAYS THE CHEAPEST!

PLUMBERS PLUMB!

90% OF THIS JOB IS NOT PLUMBING!

CONNECTING ELECTRIC TO THE HOMES MAIN CIRCUITS

WHEN YOUR ITEM IS ASSEMBLED ALWAYS USE THE SERVICES OF A FULLY QUALIFIED ELECTRICAL COMPANY TO COMPLETE CONNECTION FROM SHOWER TO HOUSE SUPPLY. LAWS DEMAND THIS IN MOST STATES. UNDERTAKING THIS ACTION YOURSELF WILL VOID YOUR WARRANTY. UNLESS, YOU ARE A QUALIFIED/CERTIFIED ELECTRICIAN. SHOULD SOMETHING HAPPEN, WE MAY ASK YOU TO PROVIDE PROOF OF QUALIFICATION.

YOUR SAFETY AS WELL AS OTHERS IS PARAMOUNT. NEVER ATTEMPT THIS YOURSELF!

SOME NOTES NOT TO FORGET

These showers are designed to be free standing and movable from their location should you have need to replace anything. ALWAYS USE Flexible braided water inlet hoses (same as your dishwasher or washing machine hoses) at least 3-6 feet long. Use flexible hoses for your waste pipe as well. NEVER install using rigid pipes and NEVER attach the unit to the wall.

ALL SHOWERS REQUIRE SEALING. THIS IS IMPERATIVE. ASK YOUR LOCAL HARDWARE STORE WHICH TYPE OF SEALANT IS BEST FOR YOU

CRATE CONTENTS

1. Crate# 1 (the large one)

1 - Whirlpool Bath Tub

1 - Roof

2 - Curved Rails (one black, one white)

2. Crate# 2 (the smaller one)

4 - Plastic Door Seals

2 - Glass Curved Doors (Large)

2 - Curved Glass (Medium)

2 - Curved Glass (Small)

1 - Left Black Glass Panel

1 - Right Black Glass Panel

2 - Aluminum Front (Wide) posts

2 - Aluminum Rear (Narrow) posts

1 - Main Back Panel Wall

1 - Bag of Installation Hardware

1 - Foot Massager

1 - Set of Clear Rubber Wedge Seal Strip (Small and Large)

1 - Set of "H" Shaped Rubber Glass Seal Strips (Small and Large)

2 - Magnetic Door Seal Strips

2 - Towel Bars

2 - Racks

Packing List



PART# 1
#4 and #6 Flat Washers
1 SET



PART# 2
#4, #5 and #6 Hex Nuts
1 SET



PART# 3
Cap Screw Cover Assembly
8 EA



PART# 4
Clear Spacers
10 EA



PART# 5
Hose Seal Washer
6 EA



PART# 6
5/8" #4 Flat Head Self-Tapping Screws
10 EA



PART# 7
1" #4 Pan Head Machine Screws
3 EA



PART# 8
1" #6 Pan Head Self-Tapping Screws
8 EA



PART# 9
1" #5 Pan Head Machine Screws
8 EA



PART# 10
1 " #6 Hex Machine Bolts
10 EA



PART# 11
1" #4 Flat Head Self-Tapping Screws
6 EA



PART# 12
Shower Door Handle
2 EA



PART# 13
Hose Clamps
4 EA



PART# 14
Door Roller Wheels
8 EA



PART# 15
Drain Plug
1 EA



PART# 16
White Rubber Seal/Stop
1 EA



PART# 17
Shower Hose
3 EA



PART# 18
Foot Massage Adapters
2 EA



PART# 19
Foot Massager Hose Adapter
1 EA



PART# 20
Foot Massager
1 EA



PART# 21
Back Rests
2 EA



PART# 22
Shower Acc.
Rack
2 EA



PART# 23
Towel Bar
2 EA



PART# 24
Hand Held Shower
Head
2 EA



PART# 25
Door Seals
4 EA



PART# 26
Clear Wedge
Window Seal Small
And Large
1 SET



PART# 27
H Window Seal
Strips Small and
Large
1 SET

SORRY, NO
IMAGE
AVAILABLE

PART# 28
Remote Control
1 EA



PART# 29
Shower Riser bar
2 EA

REMOVED

PART# 30

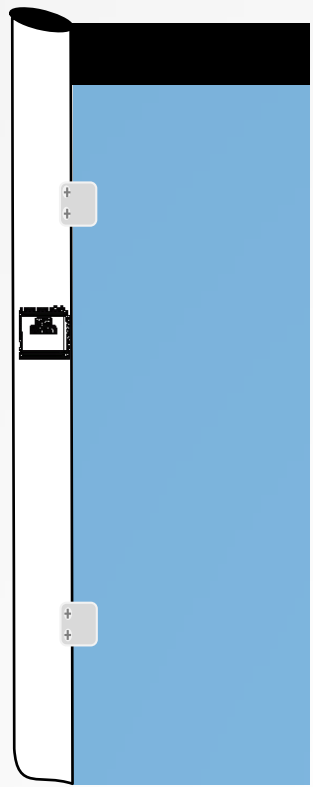

PART# 31
Left Upright Fixed Door
(Has Warning Sign on it)
1 EA

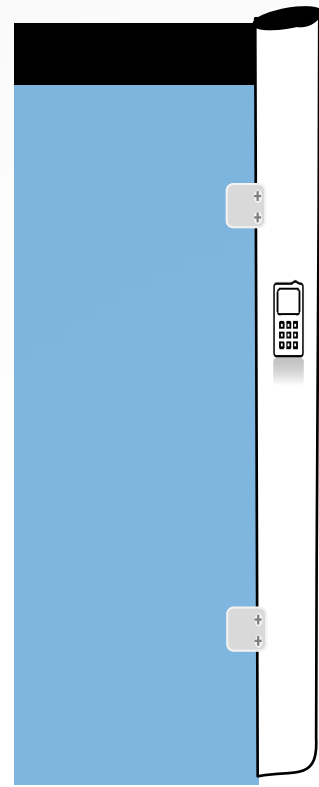

PART# 32
Right Upright Fixed Door
(Control Panel on it)
1 EA

NOT APPLICABLE

PART# 33
N/A

NOT APPLICABLE

PART# 34
N/A

NOT APPLICABLE

PART# 35
N/A

NOT APPLICABLE

PART# 36
N/A

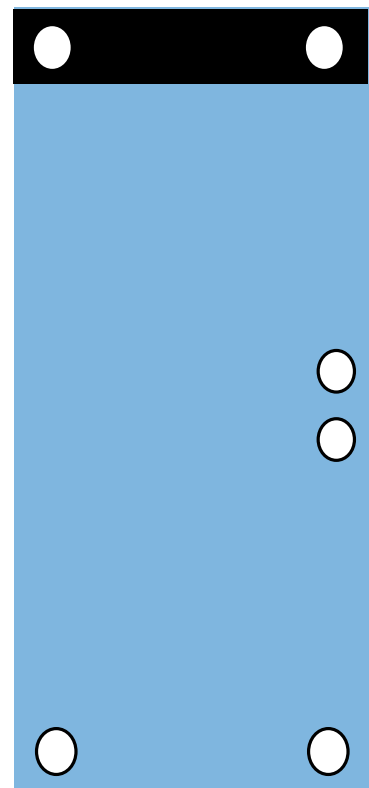

PART# 37
Left Glass Door
(Sliding Door Units Only)
1 EA

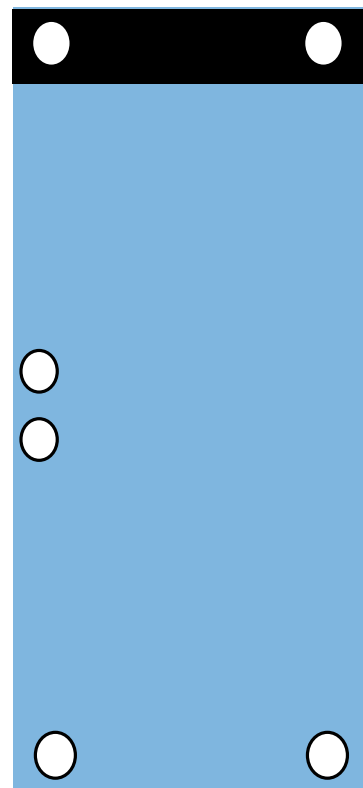

PART# 38
Right Glass Door
(Sliding Door Units Only)
1 EA

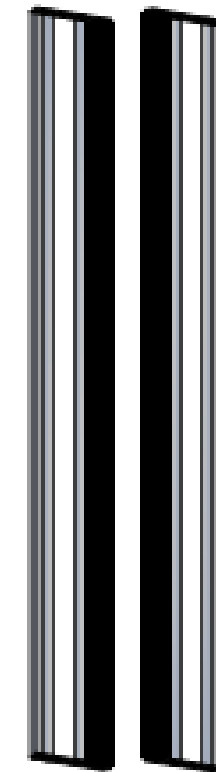

PART# 39
Magnetic Door Seals
1 SET

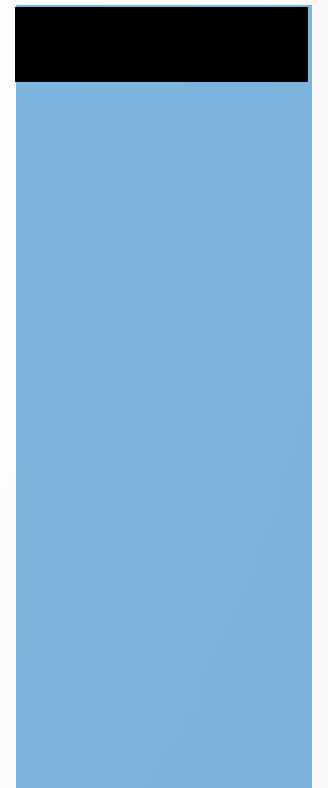

PART# 40
Left Fixed Glass
1 EA

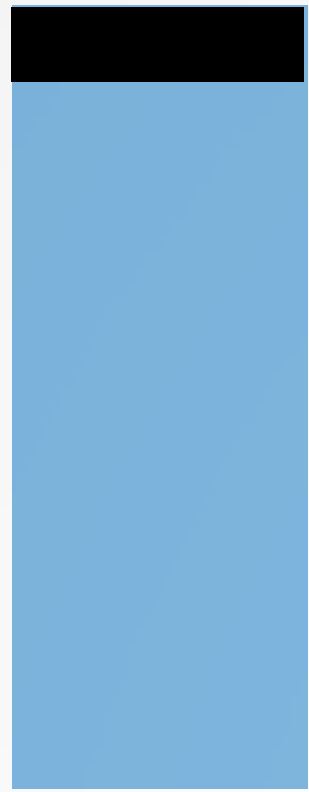

PART# 41
Left Fixed Glass
1 EA



PART# 42
Left Rear Corner
Upright Aluminum Pole
1 EA



PART# 43
Right Rear Corner
Upright Aluminum Pole
1 EA



PART# 44
Left Back Glass
(Black)
1 EA

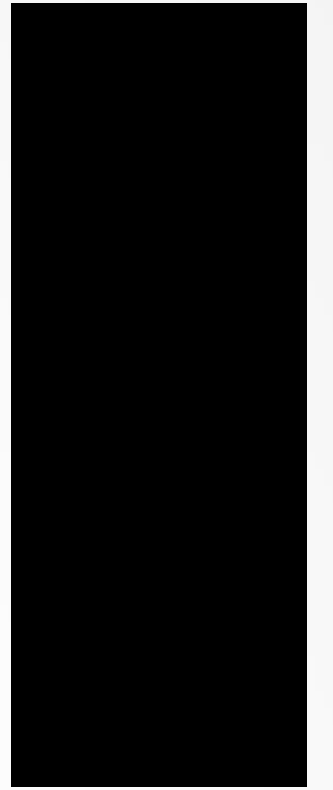

PART# 45
Right Back Glass
(Black)
1 EA

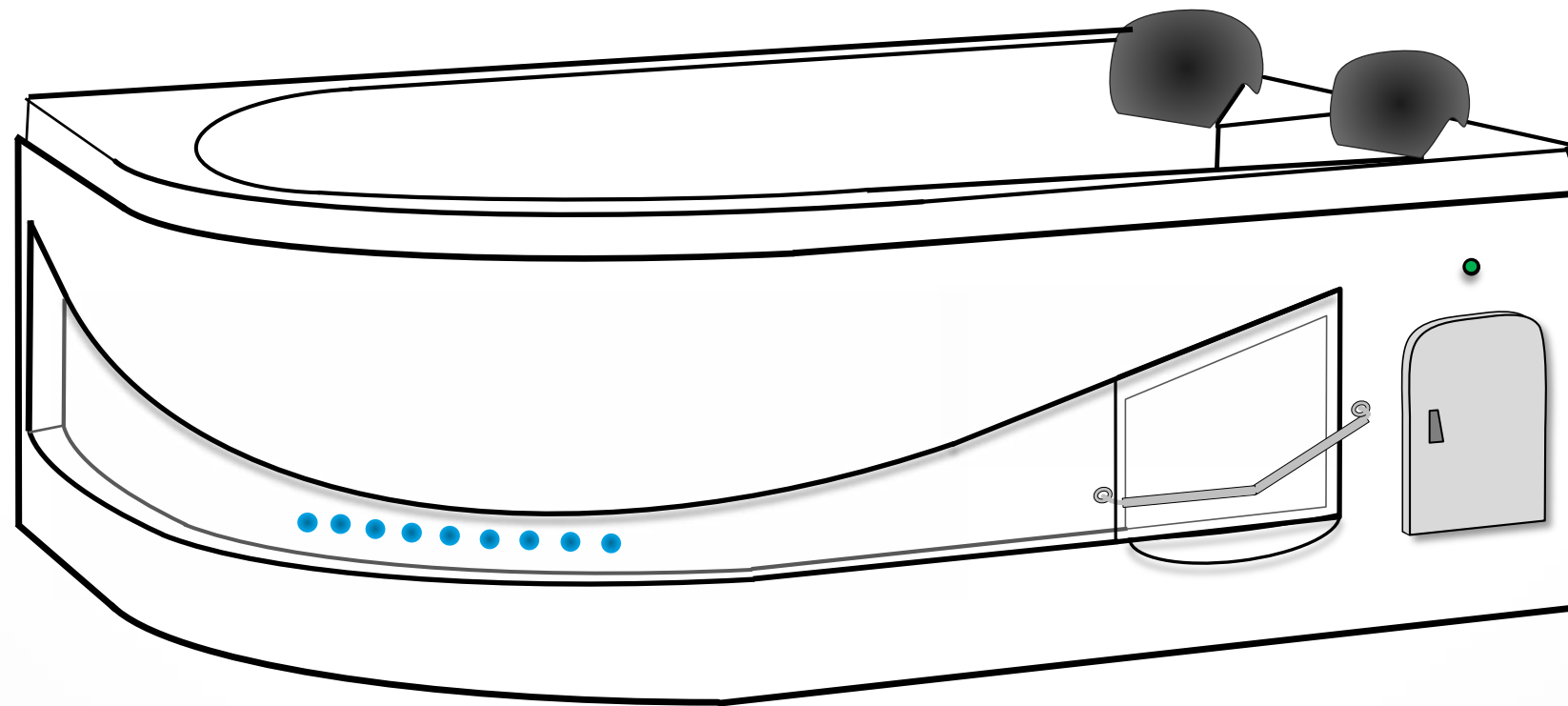

PART# 46
Whirlpool Tub
1 EA

Step 1

- Level the tub by placing the tub carefully on its side (Warning! When placing unit on its side make sure make sure you do not put pressure on the acrylic tub or any components contained underneath the tub).
- Start by screwing all level locking feet clockwise to the inward position.
- Then, Locate the furthest Level Locking Foot adjustment from the drain. Adjust those feet out one inch as shown in *figure 2*. As you move closer to the drain, adjust the feet to three quarter inches, then, half inch, and finally one quarter of an inch, or all the way in, depending on tub. There is no science behind this method and it takes in consideration that your floor is perfectly level. You may have to adjust according to your situation. The main goal is to create a sloping plane for the water to roll off properly toward the drain.
- With tub still on its side, Ensure the drain system is hand tight then apply a quarter turn of the wrench.
- Should you need to change the drainage system or purchase any adapters; the waste drain is one inch and a half male fitting. Although it is not required, changing the waste hose to a larger size is recommended for faster drainage.
- Ensure all plumbing connections are tight. Use a wrench, if needed, to apply additional tightening. However, note that too much torque applied may cause connections to crack and/or split. This is not covered by the warranty.
- Place the tub carefully on its feet. DO NOT lift, drag or pull on the acrylic while setting the tub on its side or lowering it to its feet. Although the acrylic is made of very sturdy strong material, you could still crack the acrylic. This is not covered by the warranty.
- Then, use a Carpenter's Level to make any minor adjustments to the tub.
- Optional Step: Once Level, if you are able to fill with about an inch of water, fill and check the direction of the water drainage to ensure it is flowing smoothly toward the drain.
- Once the tub is level, you can proceed to Step 2, Pre-Fab. See *Figure 1* in your manual.

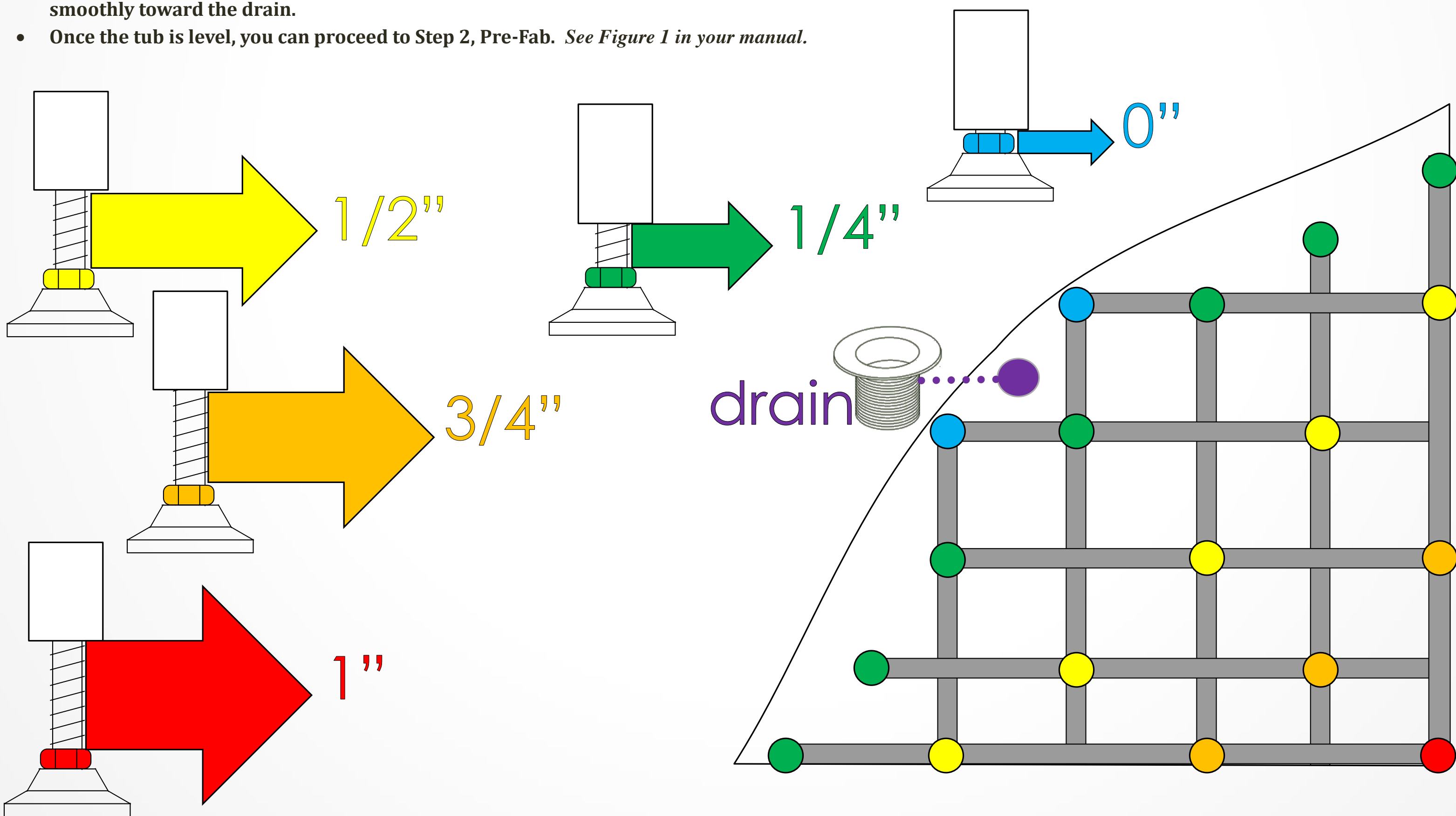



A. Connect the flex drain hose to the drain



B. May need a 90 degree elbow to connect to your homes waste drain. Items pictured may be different than what you have in your crate and some you may have to purchase at your local hardware store.

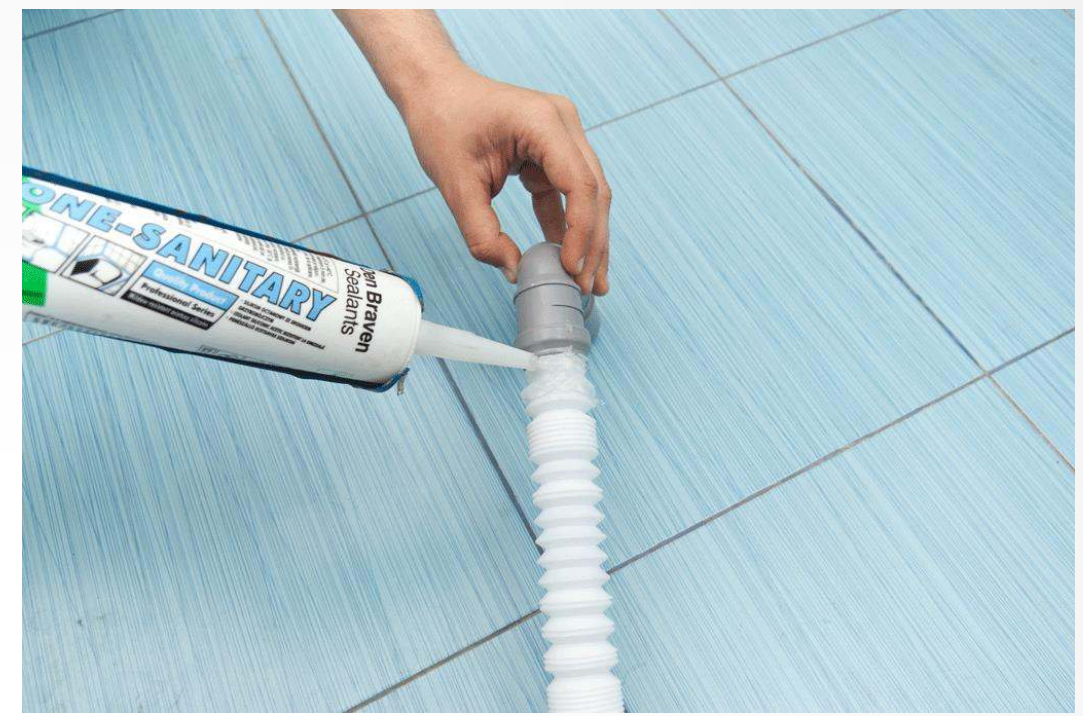

C. Use silicone glue to secure your adapter to your flex hose.

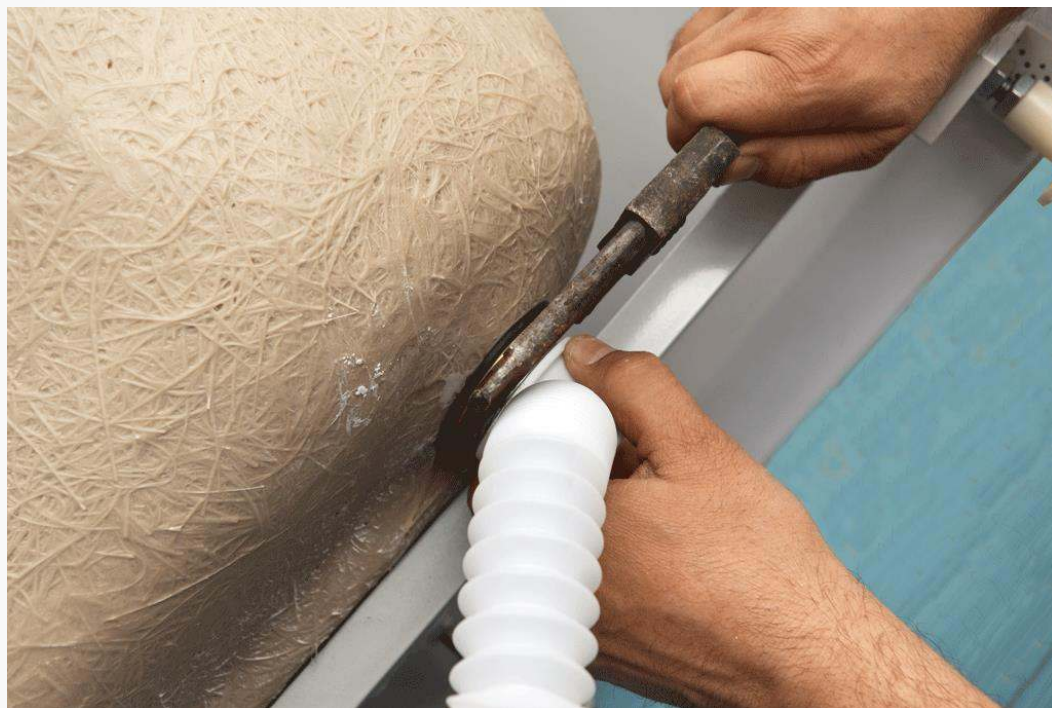

D. Ensure your drainage system does not leak.

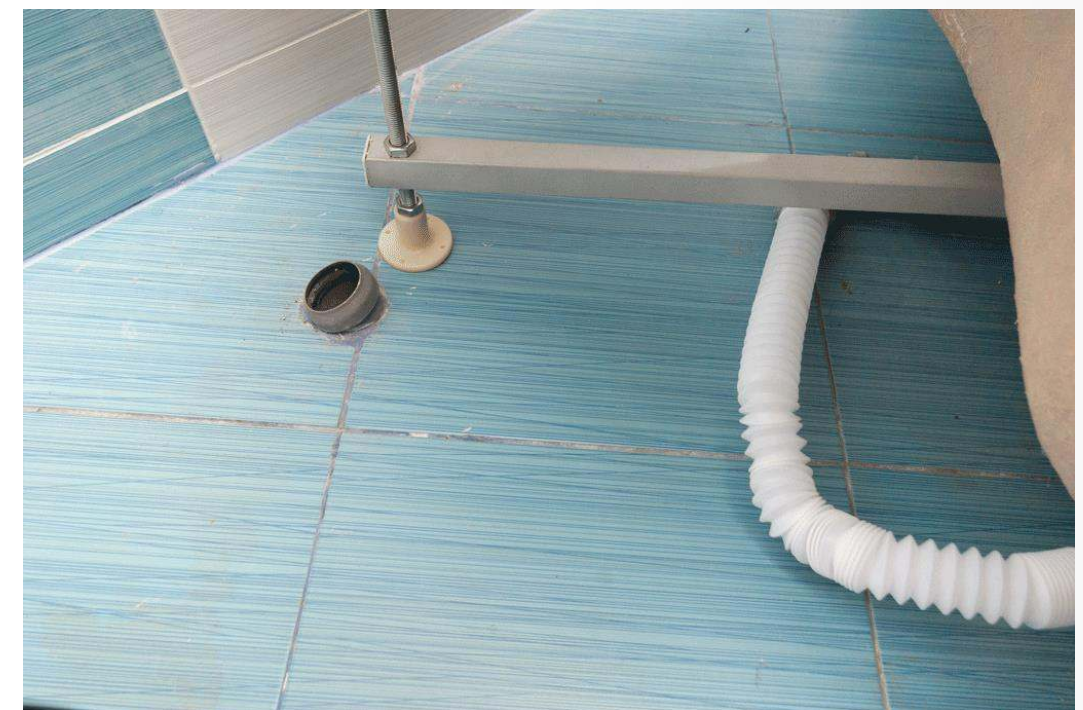

E. Make your final connection.

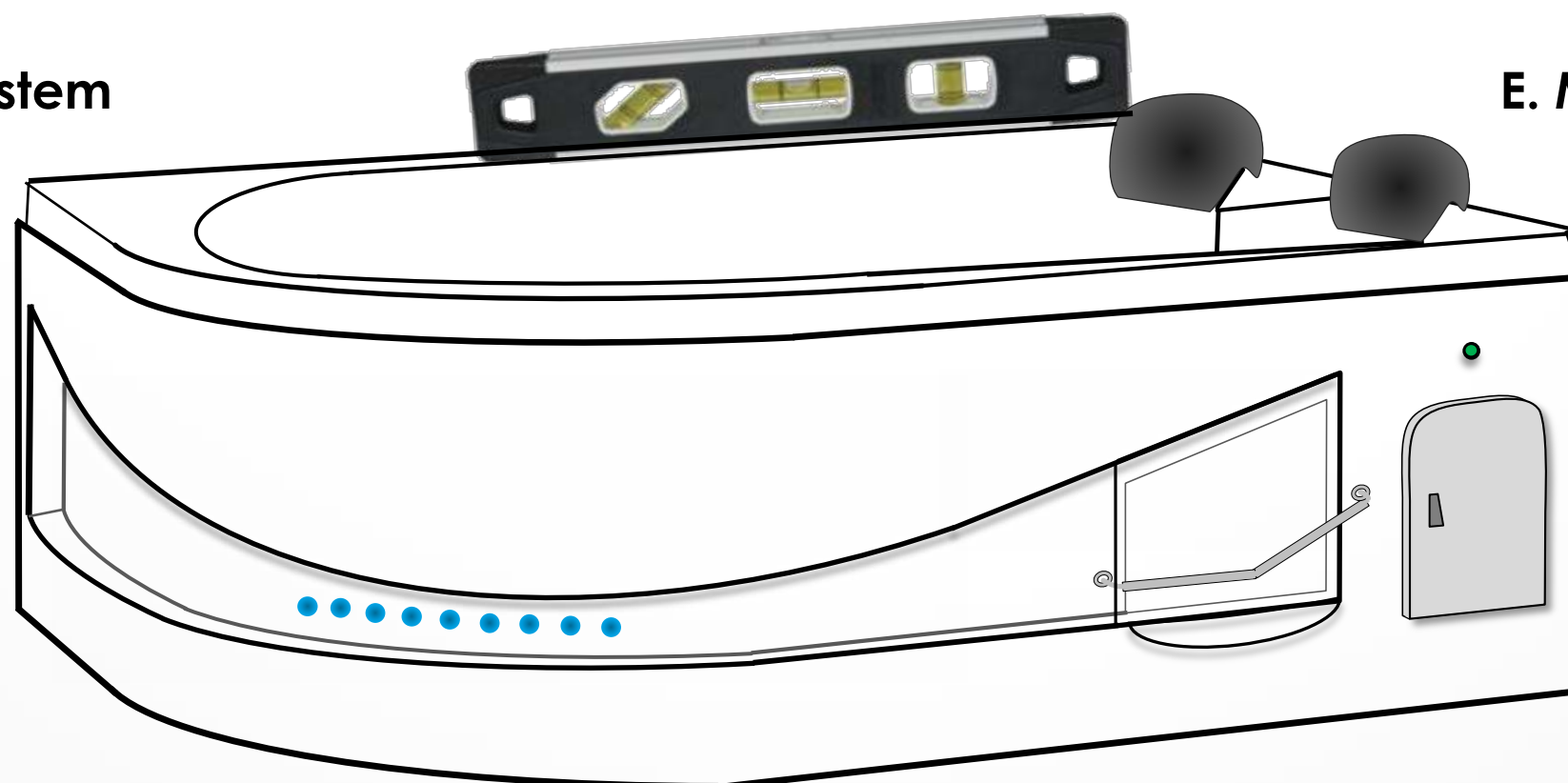

Step 2

Parts Needed: Part# 1, 2 and 10

Tools Needed: Pliers, 6mm Wrench

Install The Main Shower Panel as depicted below. While placing the main unit install the large clear seal wedge in between the tub and the unit. Cut to fit. See the blue line for example.

Install the Main Shower Panel along the back side of the tub as Pictured. Use the large Hex Bolts, 2 Washers on each Bolt and one Hex Nut.

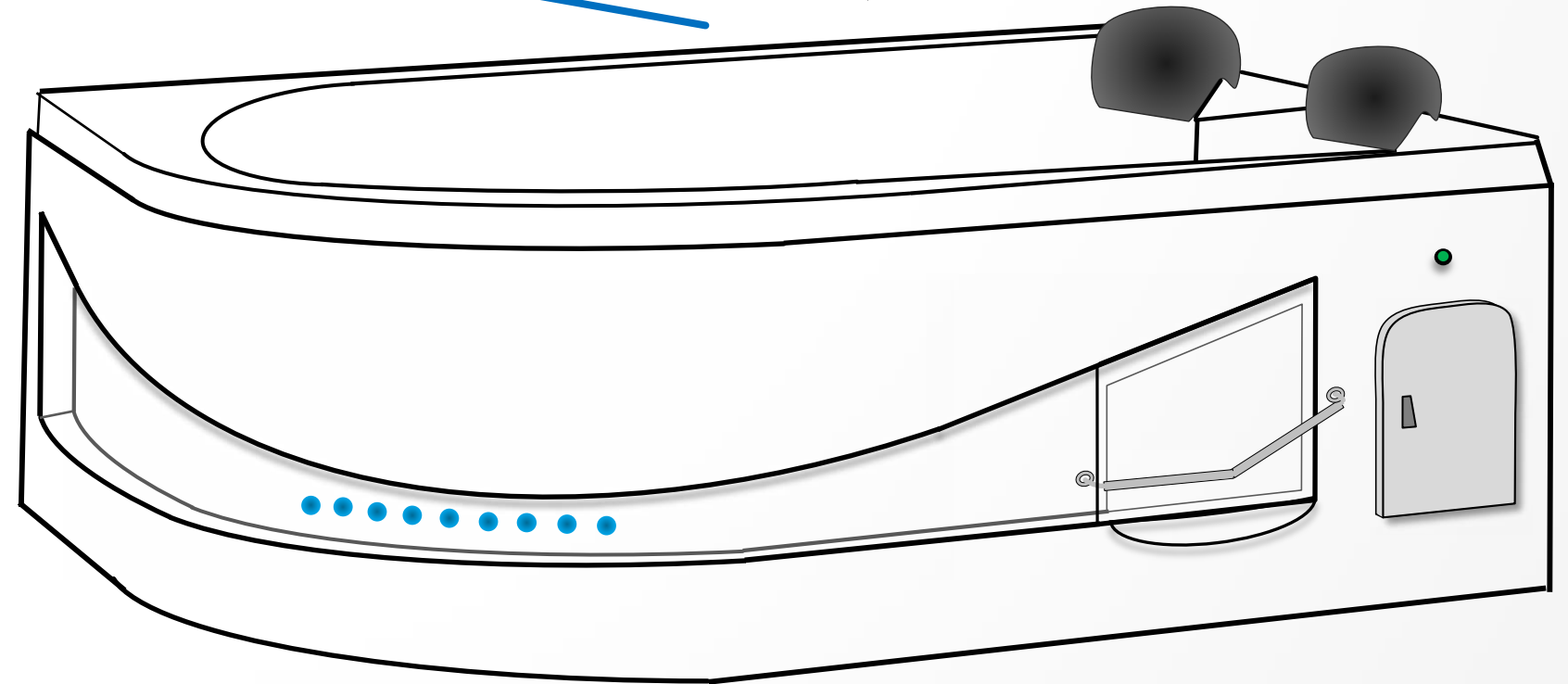
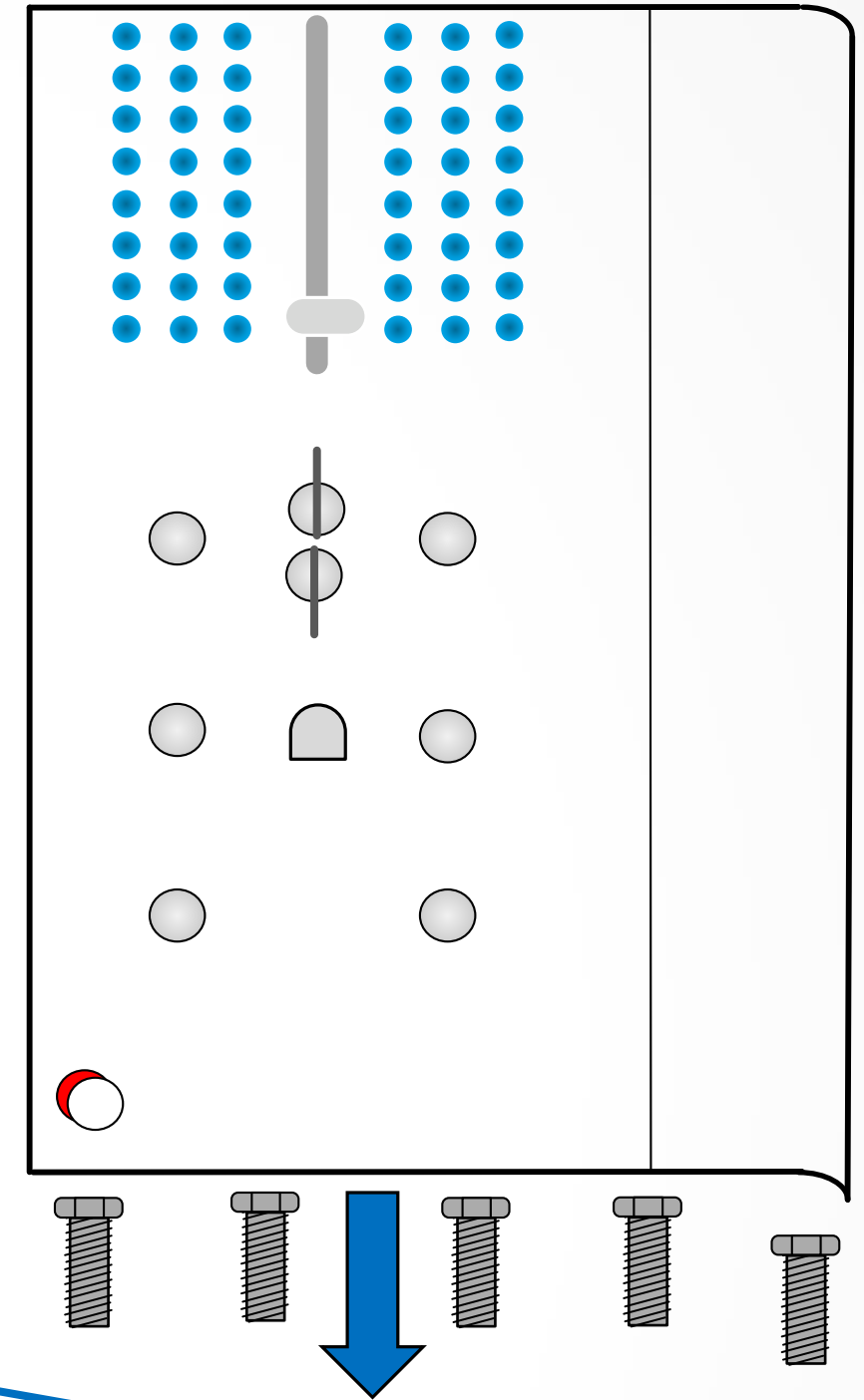
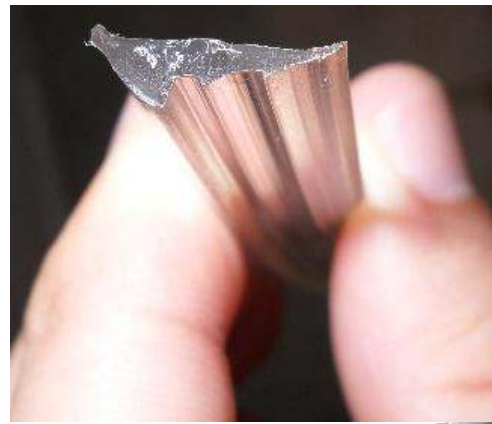

Parts Needed: Part# 18, 20, 22, 23, 27, 44 and 45

Tools Needed: Philips Screw Driver

Install the racks, towel bars and foot massager as shown below.

Install the seal strip as shown below.

Part# 27 "H" Seal Strip

Connect Part# 22 & 23 to both Shower Panel Part# 44 & 45. The hardware required will be packaged together

Part# 18

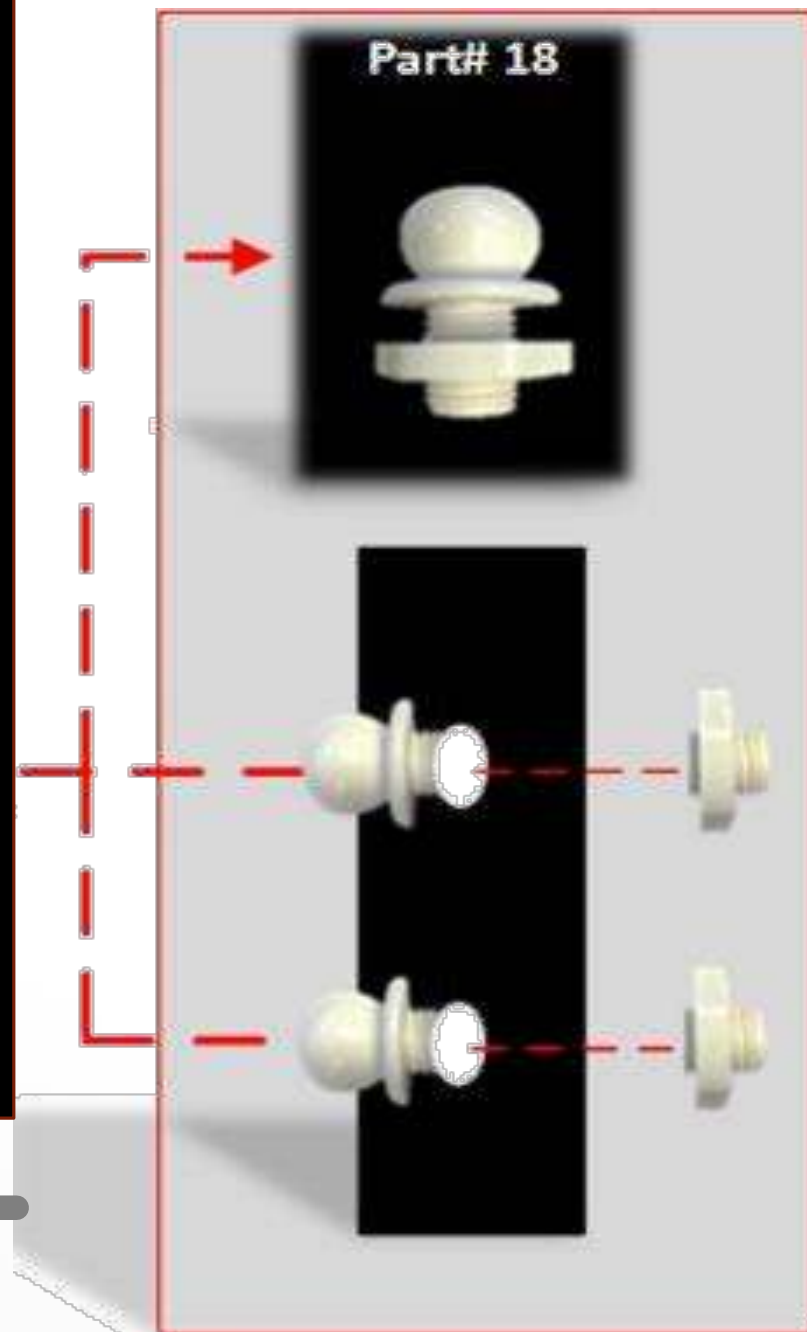
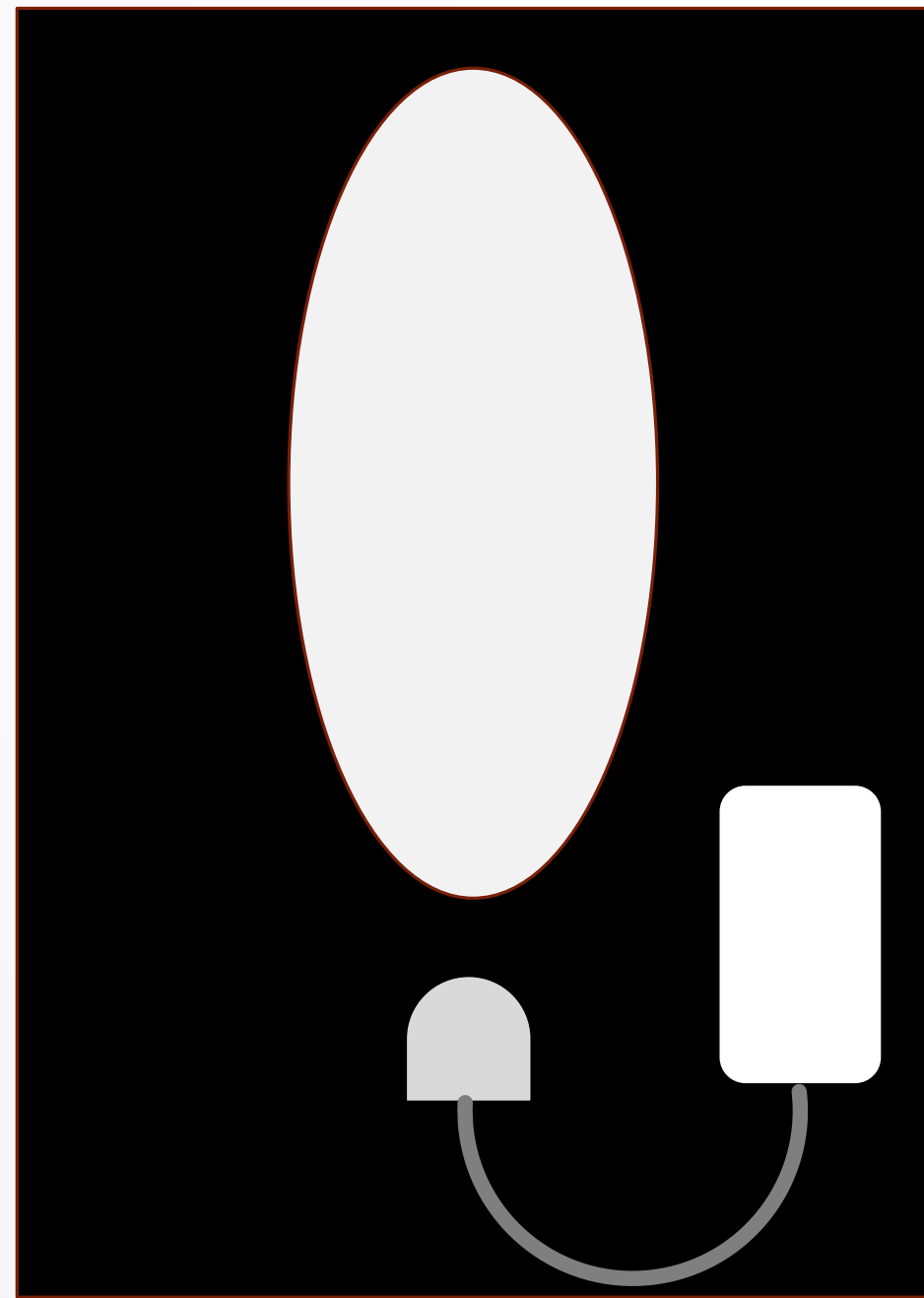

For Sliding Glass Doors Only

Parts Needed: Part# 14

Tools Needed: Pliers, Flat Head Screw Driver

a.) Install Part# 14 as outlined below. Pay attention to the mechanics of the roller wheel. Using a straight screw driver will allow you to adjust the door up and down. Tightening the Hex Nut will lock it into place. Finish by placing the metal cap on the end.

b.) After the wheels have been put on both top and bottom of the glass, place the top roller wheels into the upper arch track section. Use a straight screw driver and turn the bolt until the glass is resting in its lowest setting.

c.) Now place the lower roller wheels in the lower arch track section. Use a straight screw driver adjust the wheels in the upward setting, as to make the wheels from top to bottom safely latch on to the arch supports. Continually adjust top and bottom until the glass is level. Then lock in place using the Hex Nut.

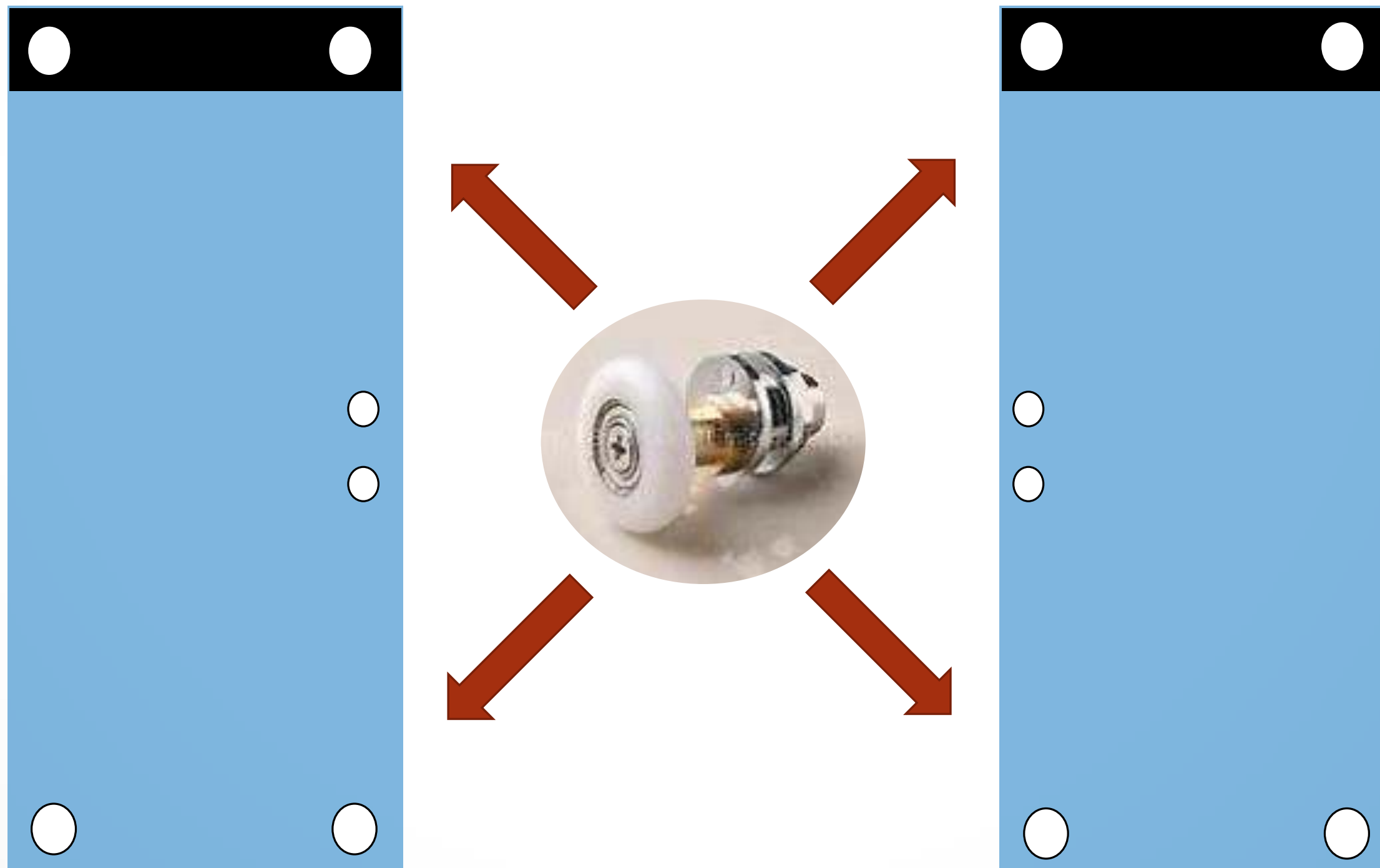

Sliding Glass doors only

Parts Needed: Part# 25, Part# 39, Part 12, Part# 37 and Part# 38

Tools Needed: Philips Screw Driver

a.) Install the side door seals and the Magnetic Door Seal. Next Install the Door Handles

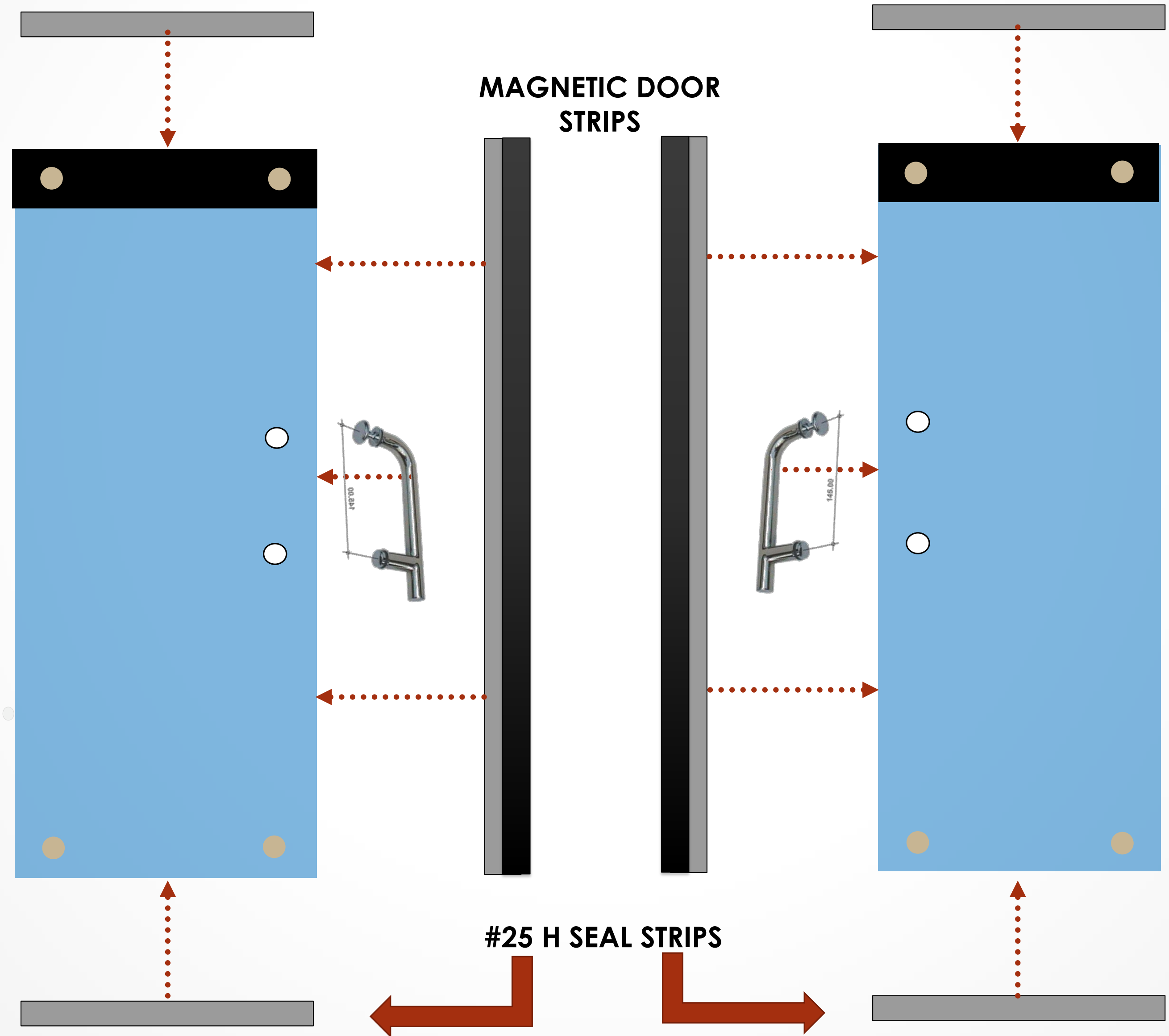

Fixed Door Applications Only

Parts Needed: Part# 25, Part# 39, Part 12, Part# 37 and Part# 38

Tools Needed: Philips Screw Driver

a.) Install the side door seals and the Magnetic Door Seal. Next Install the Door Handles

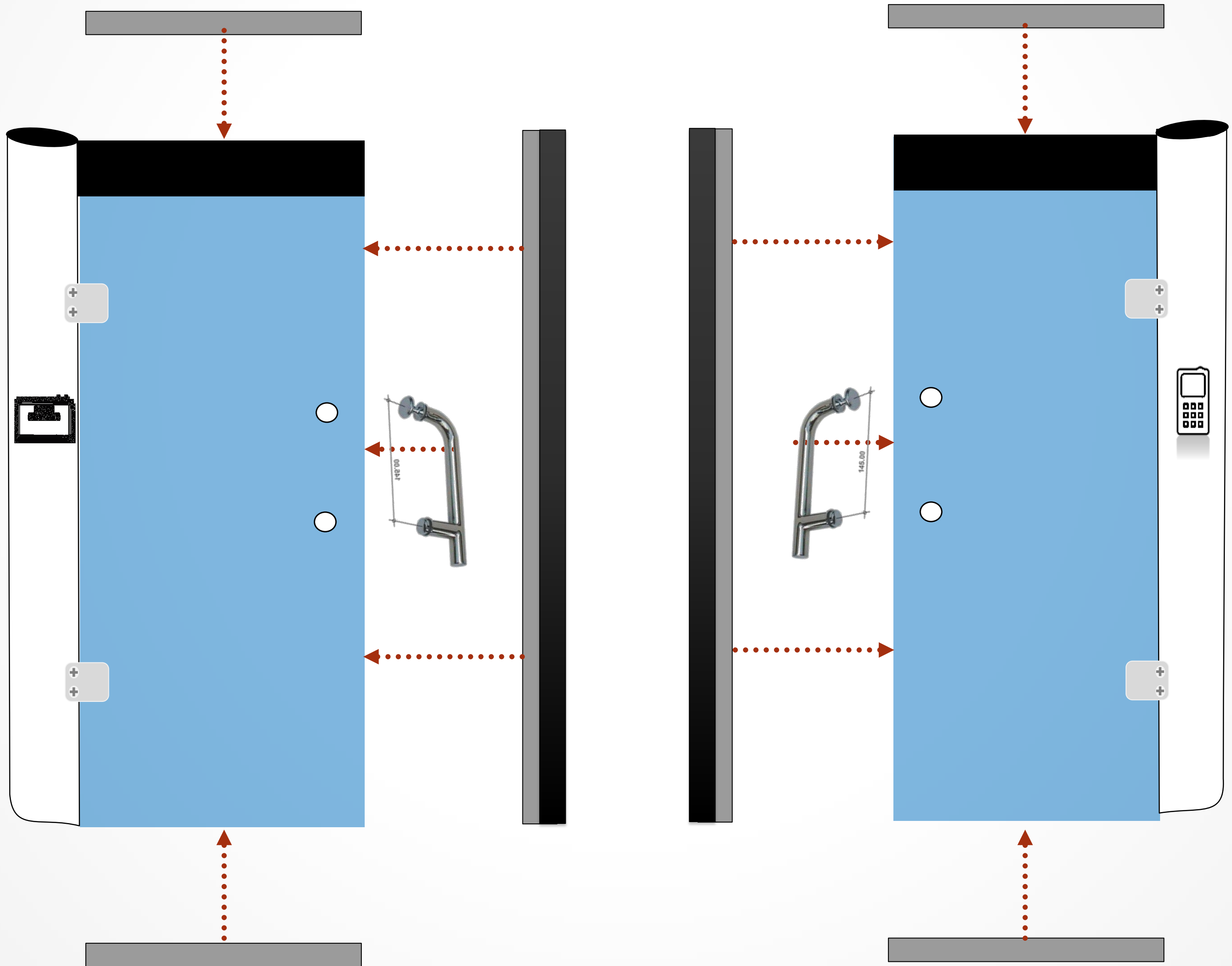

Install the Main Shower Panel along the back side of the tub as Pictured. Use the large Hex Bolts, 2 Washers on each Bolt and one Hex Nut.

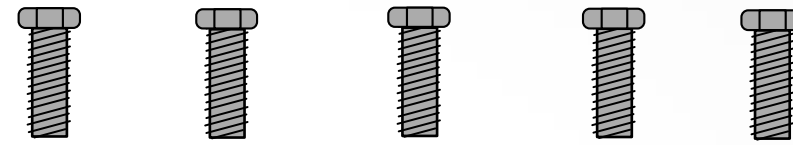

Parts Needed: Part# 1, 2 and 10

Tools Needed: Pliers, 6mm Wrench

Install The Main Shower Panel as depicted below. While placing the main unit install the large clear seal wedge in between the tub and the unit. Cut to fit. See the blue line for example.

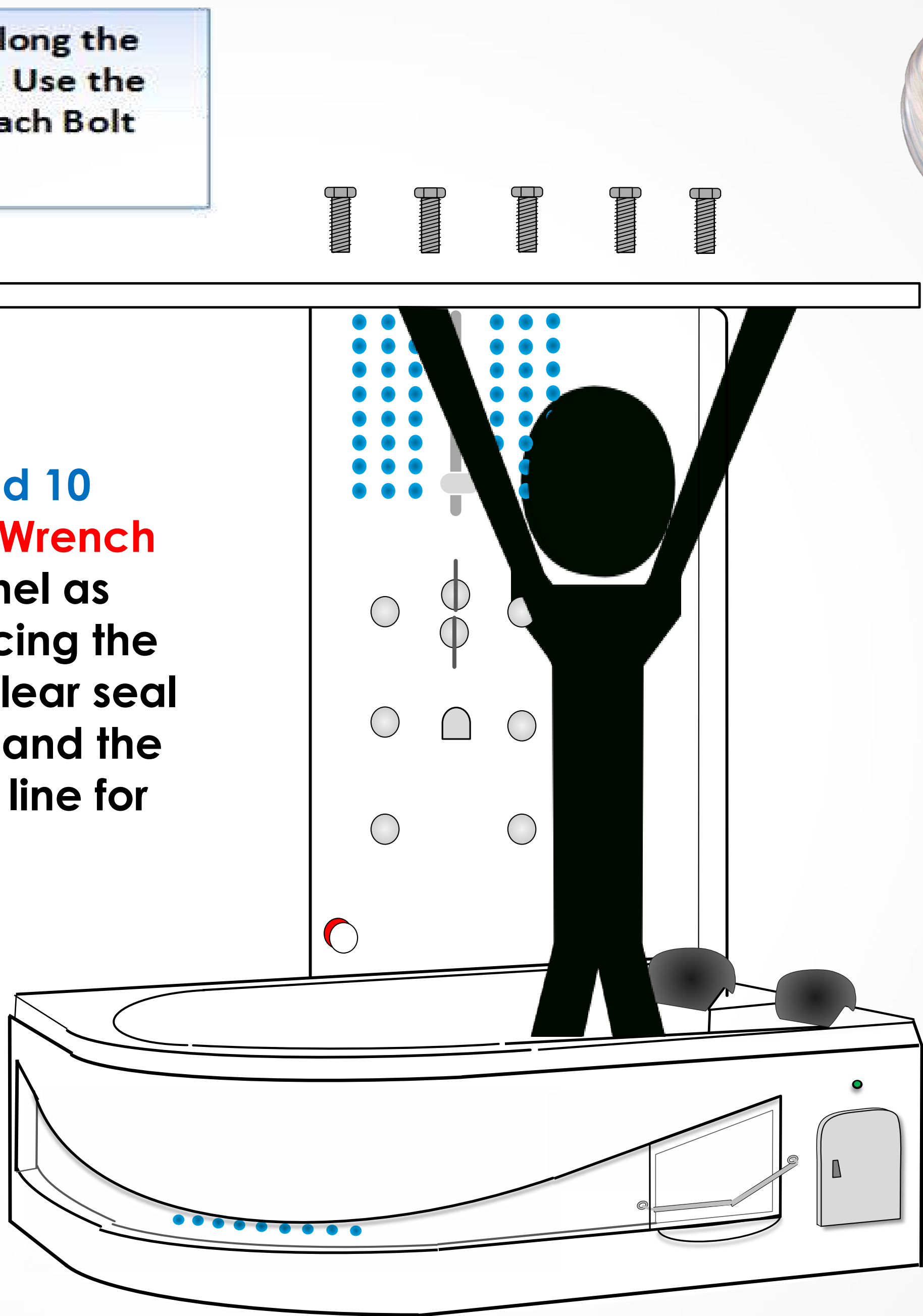

Tools Needed: Pliers

Secure the Fixed showers doors by clipping into the grey tub mounting brackets on the tub. Then, using the ceiling mount retaining brackets, slide the metal bracket into the pole and the screw through the hole in the ceiling. Then screw them together.

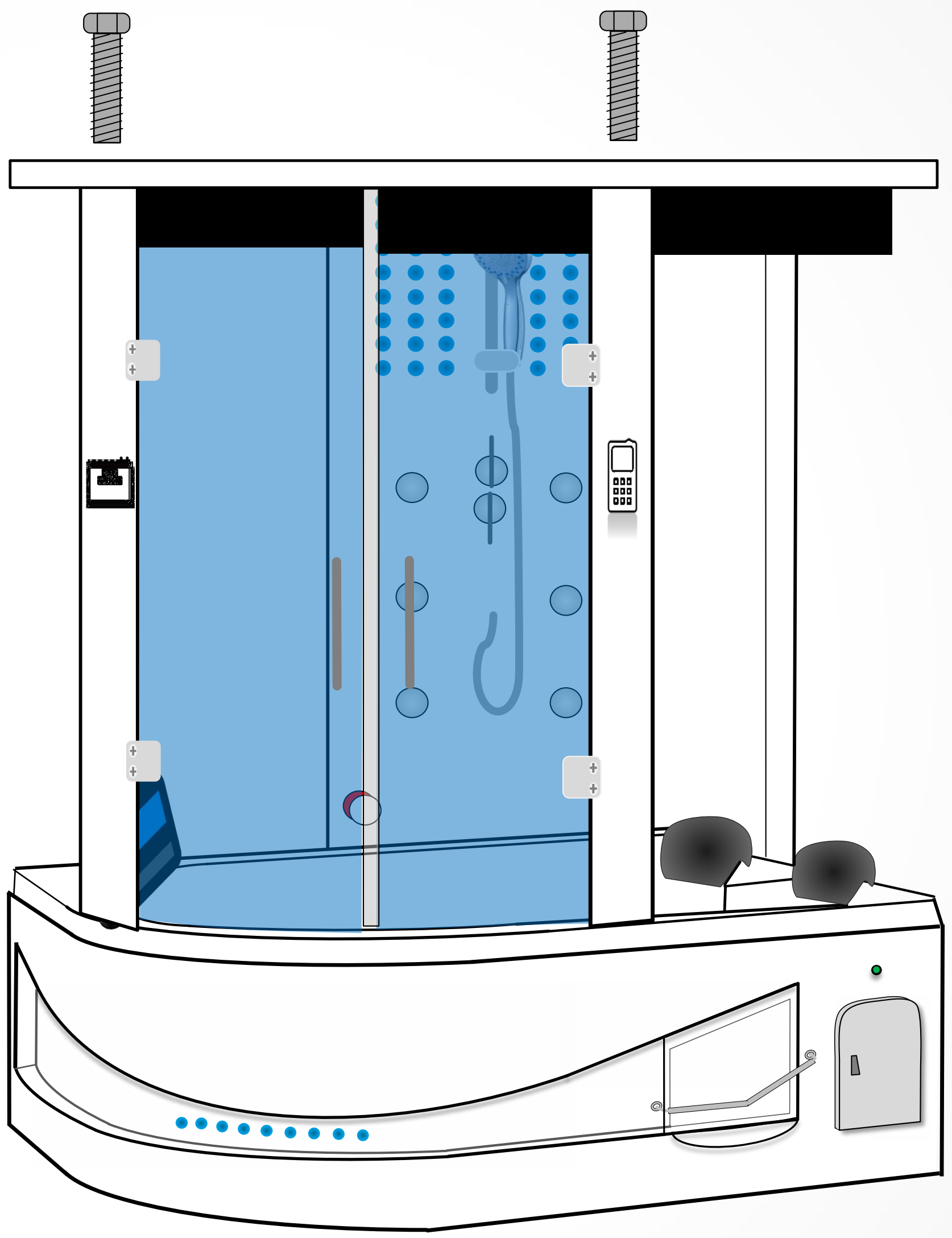

Tools Needed: Pliers, Screw Driver

A. Place part number (40), Left fixed glass in.

B. Then, part number (42), the back corner post in. Making sure the hex nut and washer are removed before placing the corner posts in.

C. Reattach the Washer and Hex nut on the underside of the tub to the screw insert on the back corner post.

D. Slide the Left fixed glass into the back corner post channel first.

Slide part number (44), the Black Glass section into the Main Shower Control Panel. (The end without holes should be the end that slides into the channel on the Main Shower Control Panel). Then, Place the Black Glass with the hole side against B.

E. Bolt B into the ceiling section of the shower top. Finally, repeat the process on the opposing side.

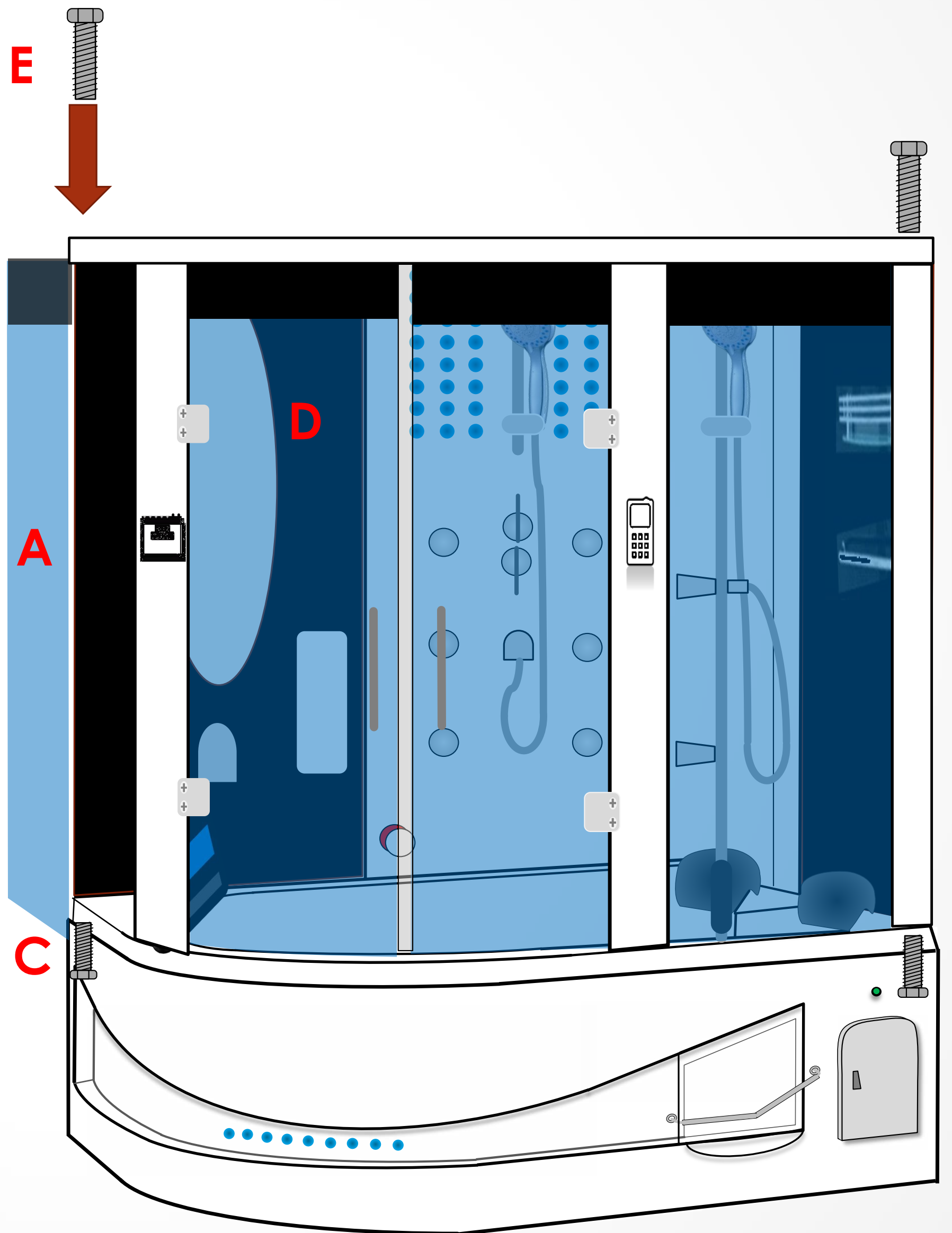
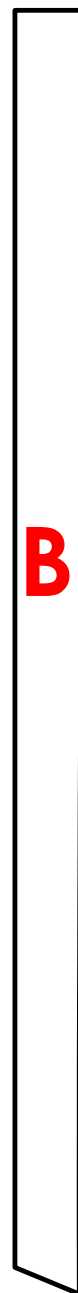

Using part numbers (1),(2), (3) and (9), assemble the black glass to the back corner posts. If the holes do not line up, then you may have the wrong back corner post. Stop and switch rear posts.

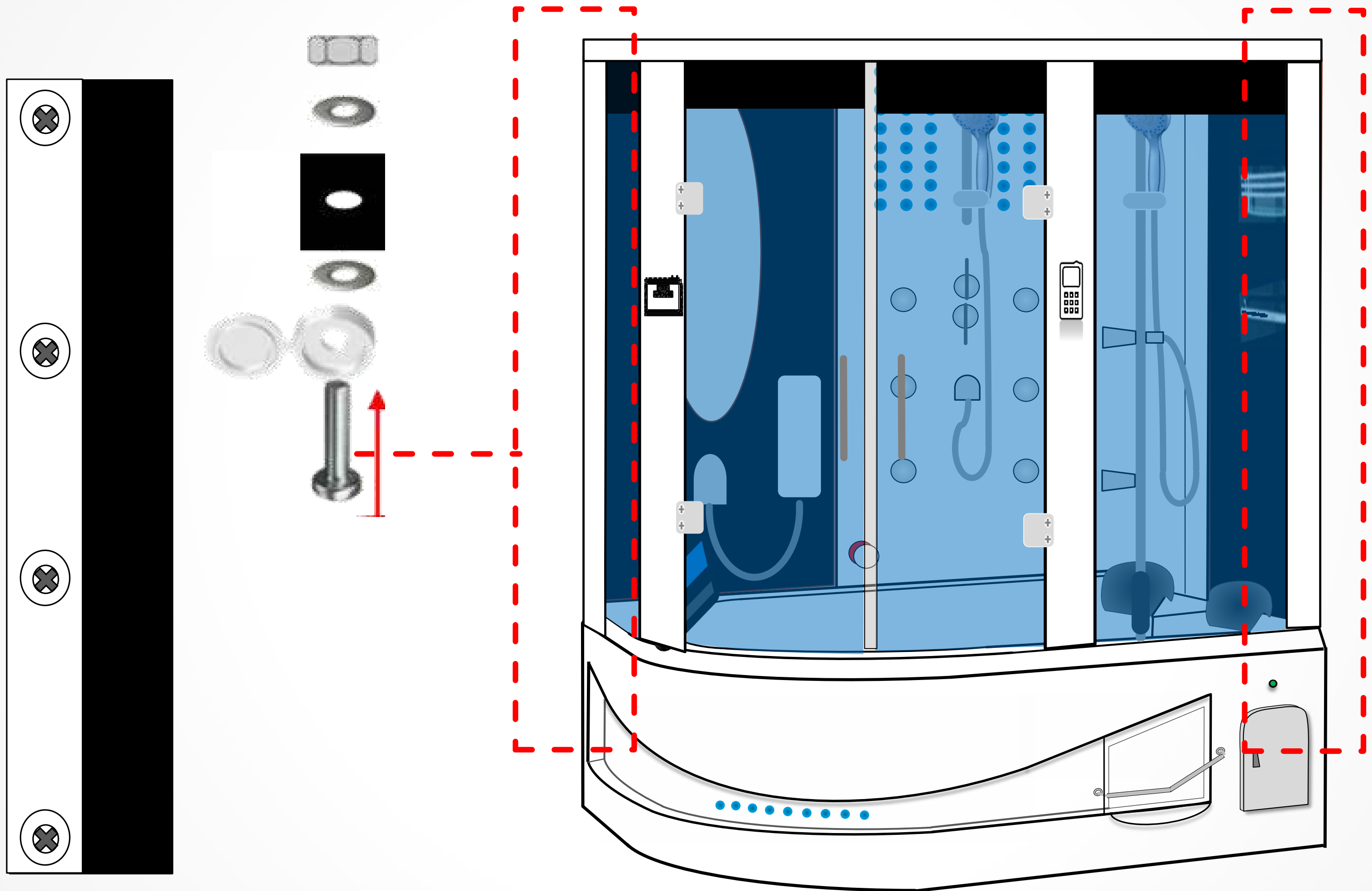

Step 10 Hose Connection Diagram

Use Plumbers Tape on your final pipe connections
See note 1 for Valve Identification

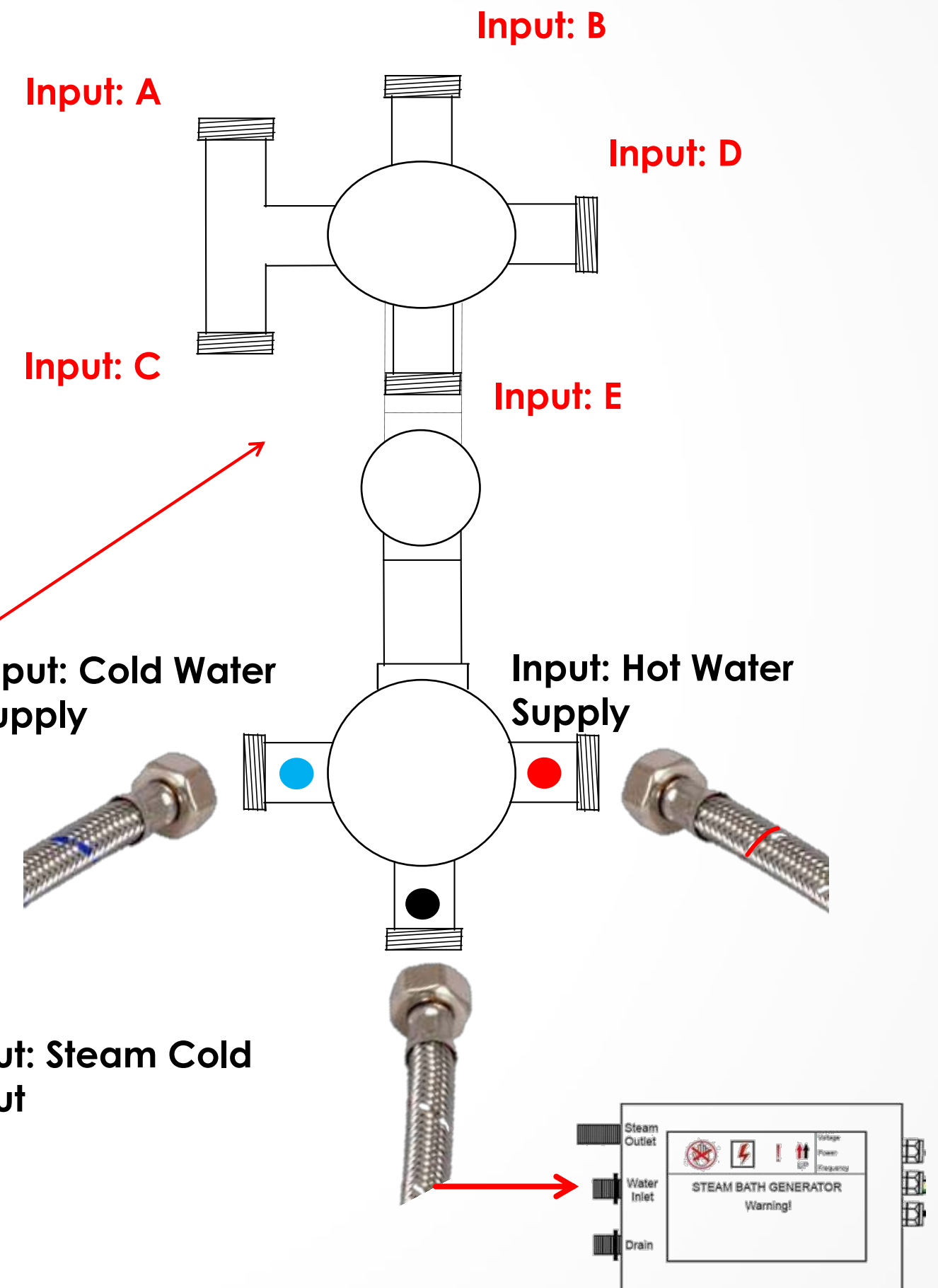
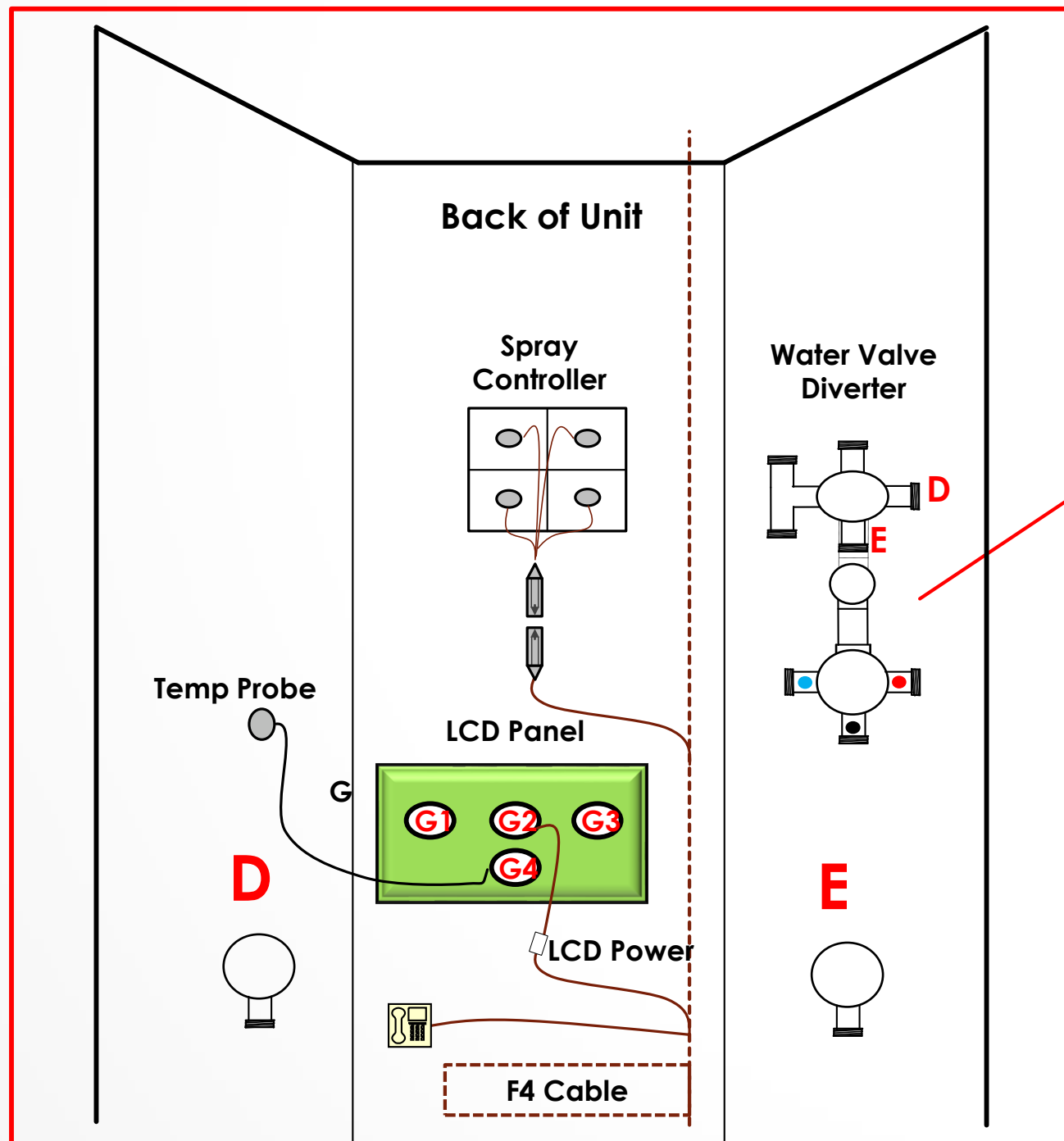
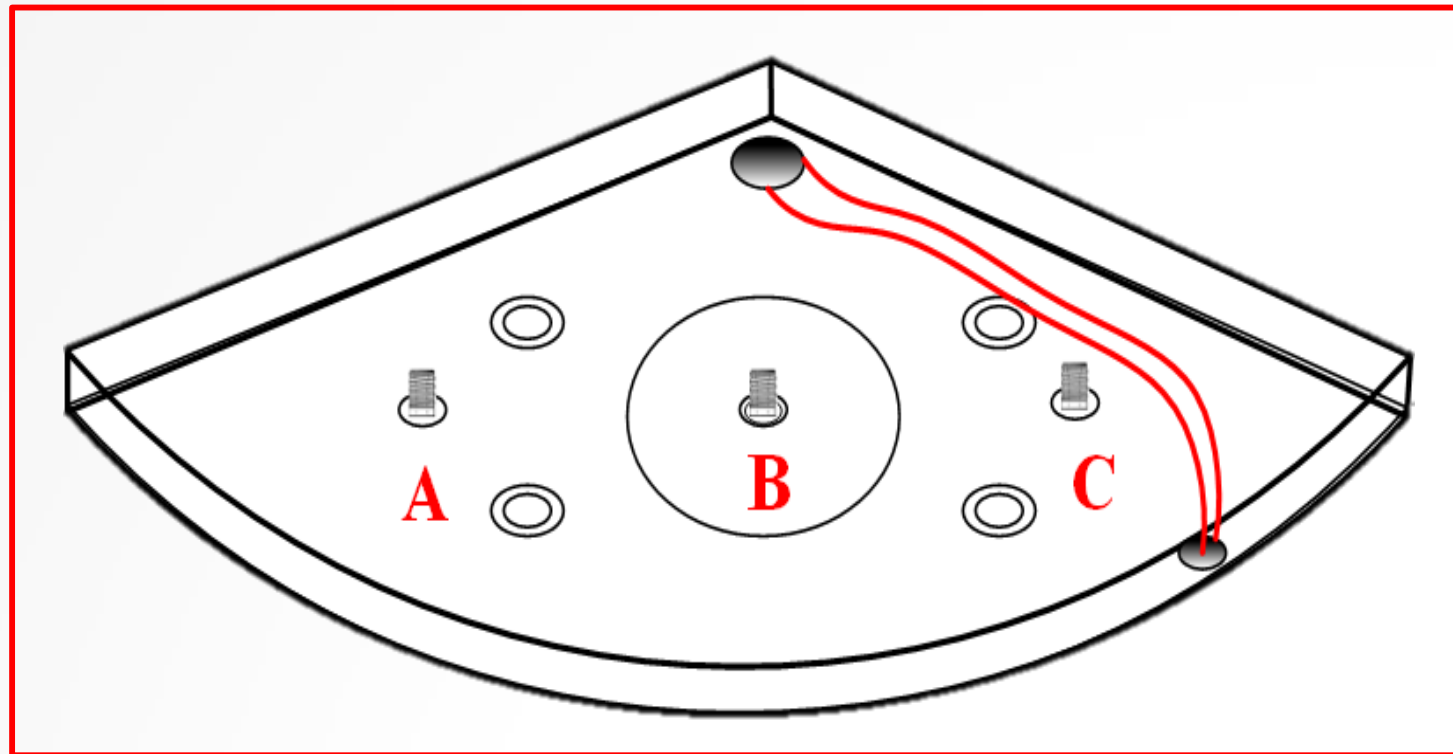

Click Anywhere to begin

Electrical Connections

Tools Needed: Small Philips Screw Driver

F1 = To Power Supply 220V 30A Outlet

F2 = No actions required

F3 = No actions required

F4 = To top of shower Ceiling

F5 = Connect the USB to

F6 = No action required

F7 = No action required

F8 = No action required

F9 = To LCD Screen connection G3

G1 = To Satellite, Cable Box or other TV Source

G2 = LCD Power, AV Cable for DVD Player, Temp Probe (See Step 12 cont. Diagram), G4 Connection from H

G3 = Junction Box Connection

G4 = MP3 Connection from H Control Panel, Tub Temp Probe (See Step 11 Diagram)

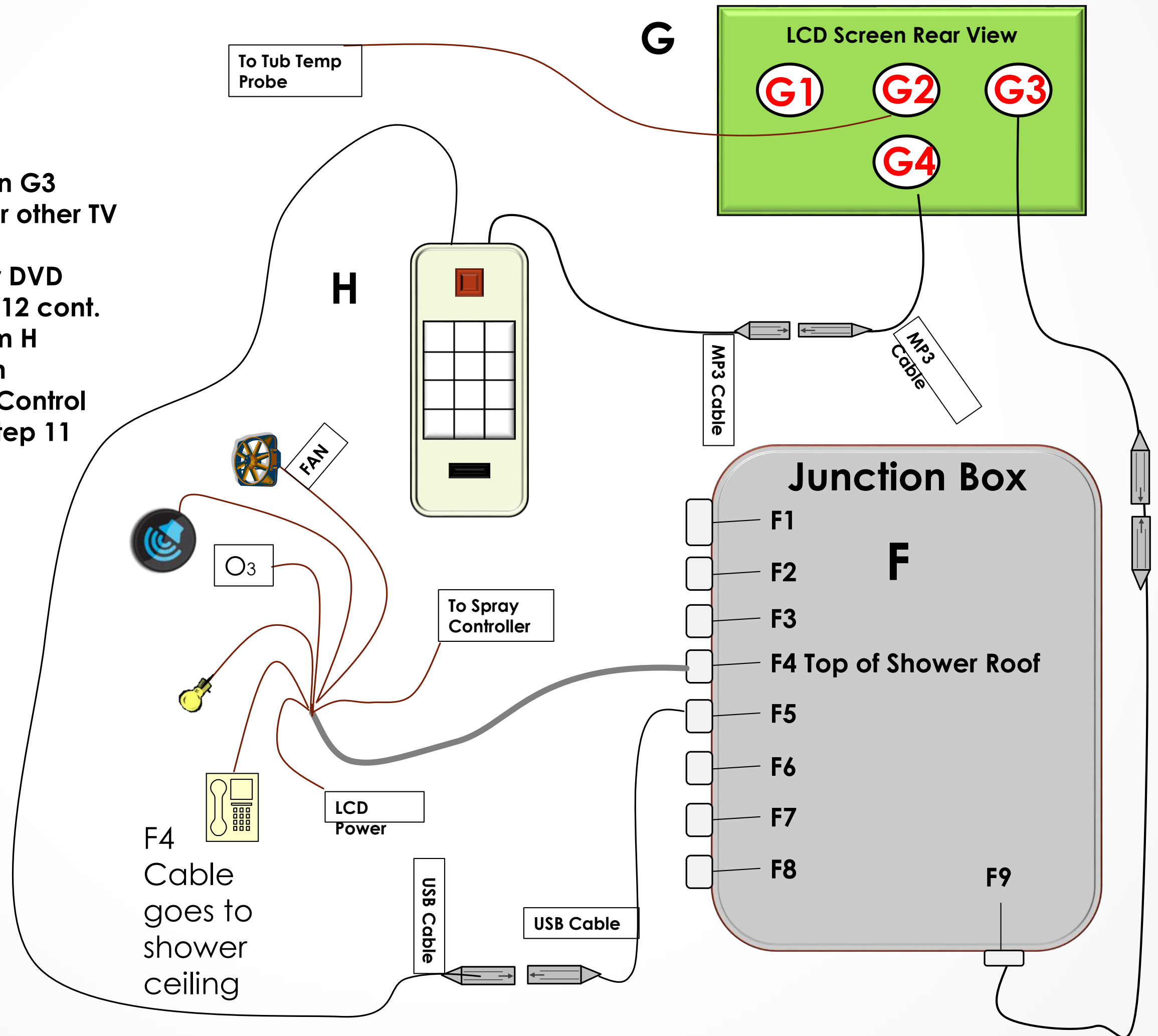

Cont. Electrical Connections

Tools Needed: Small Philips Screw Driver

G1 = To Satellite, Cable Box or other TV Source

G2 = LCD Power, AV Cable for DVD Player, Temp Probe (See Step 11 Diagram), G4 Connection from H

G3 = Junction Box Connection

G4 = MP3 Connection from H Control Panel, Tub Temp Probe (See Step 11 Diagram)

(See Step 11 Diagram)

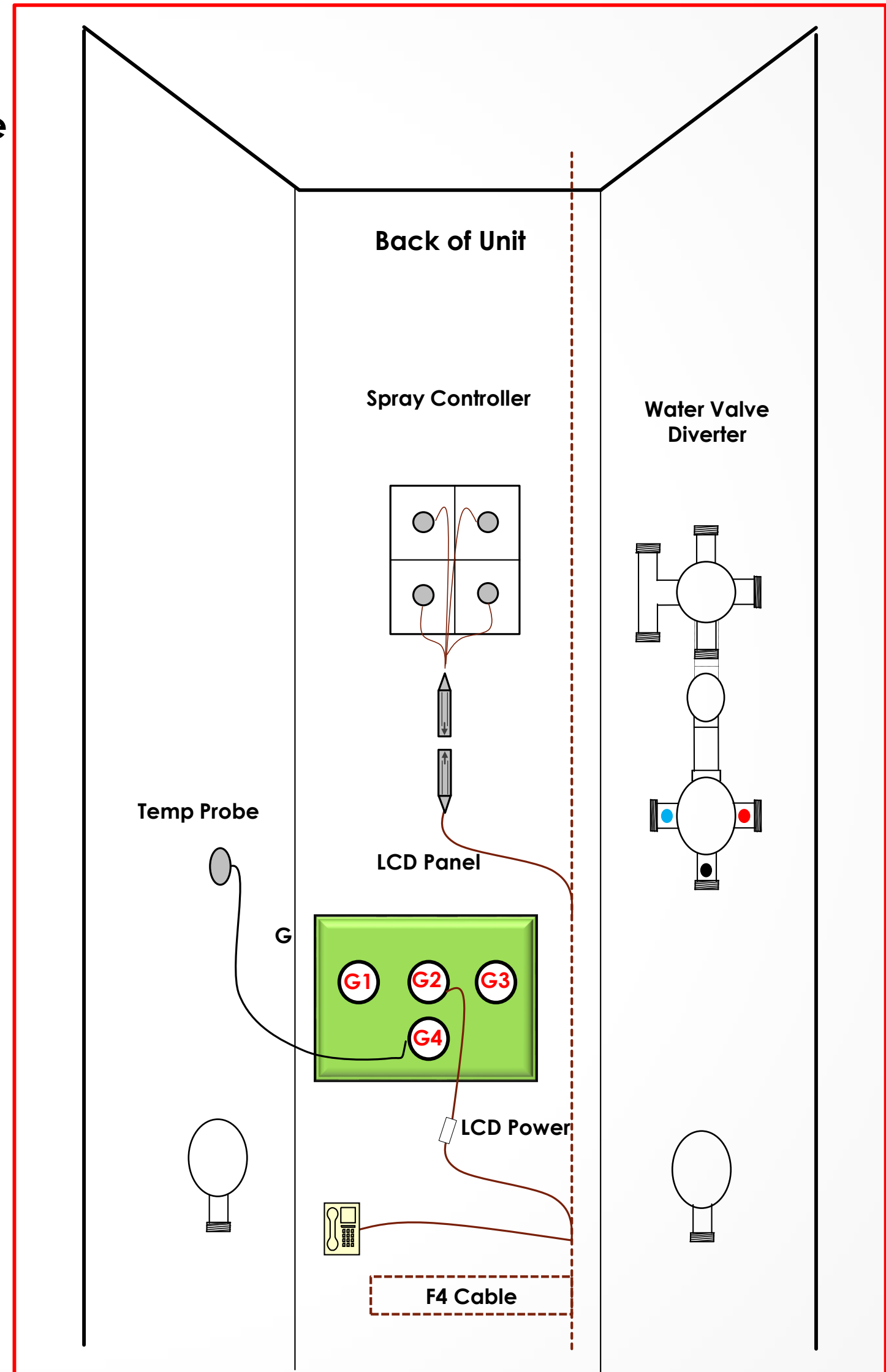
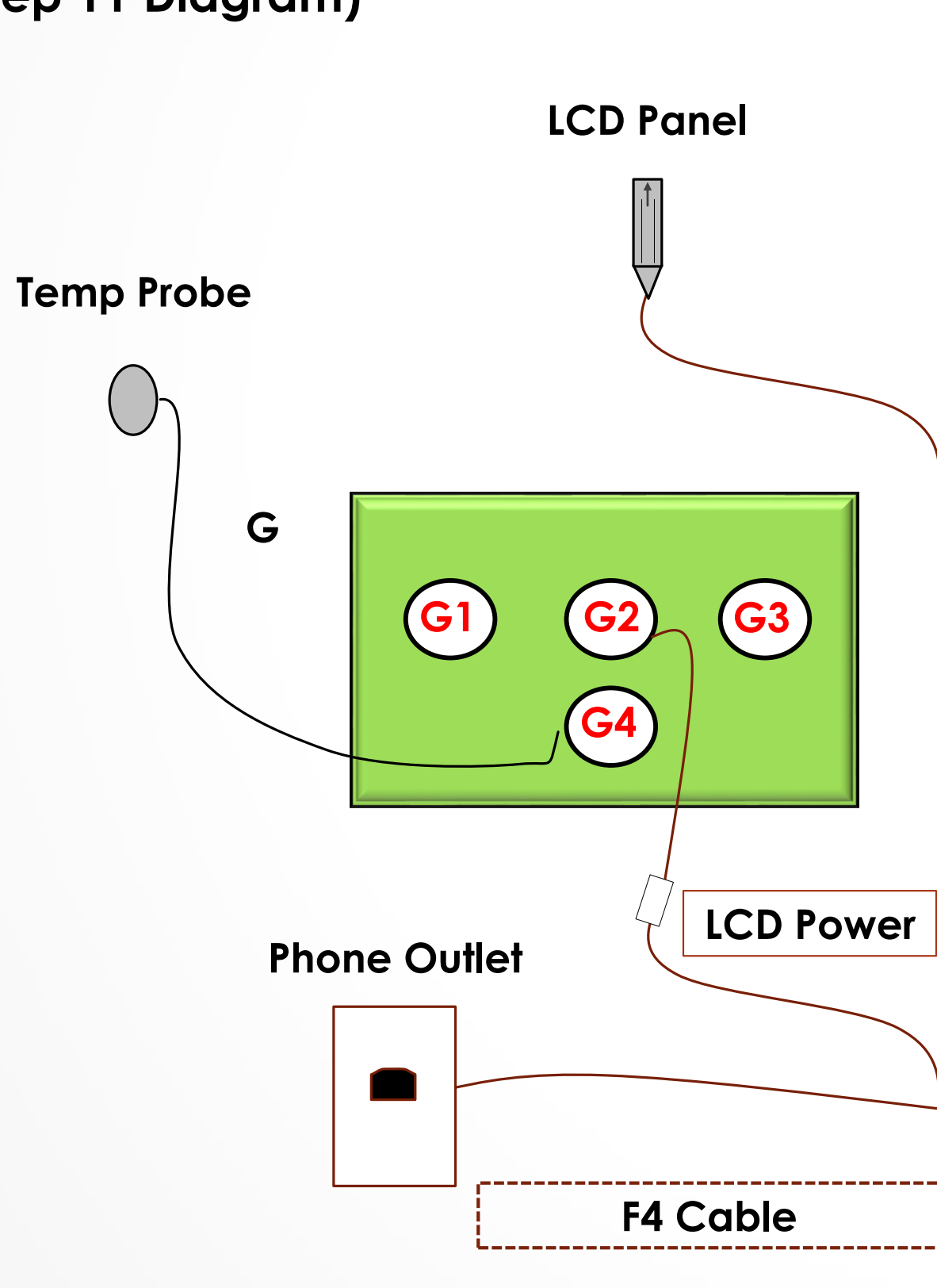

Top Electrical Connections

Tools Needed: Small Philips Screw Driver

Using the F4 Cable from the Junction Box, run the cable through the holes provided all the way up to the shower ceiling. Each cable from each device will have an identifying label on what to connect to. See diagram Below.

See Step 13a for light connections.

The lights will have a 4 bar screw connector.

On the back of the Main Shower panel is two cables one coming from each of the LED lights on the main shower panel. Run these cable to the ceiling.

Using those two cables and the light cable coming from the top middle of the shower, hold all of the solid red lines in one hand and twist them together. Then do the same thing separately to the red and black wires.

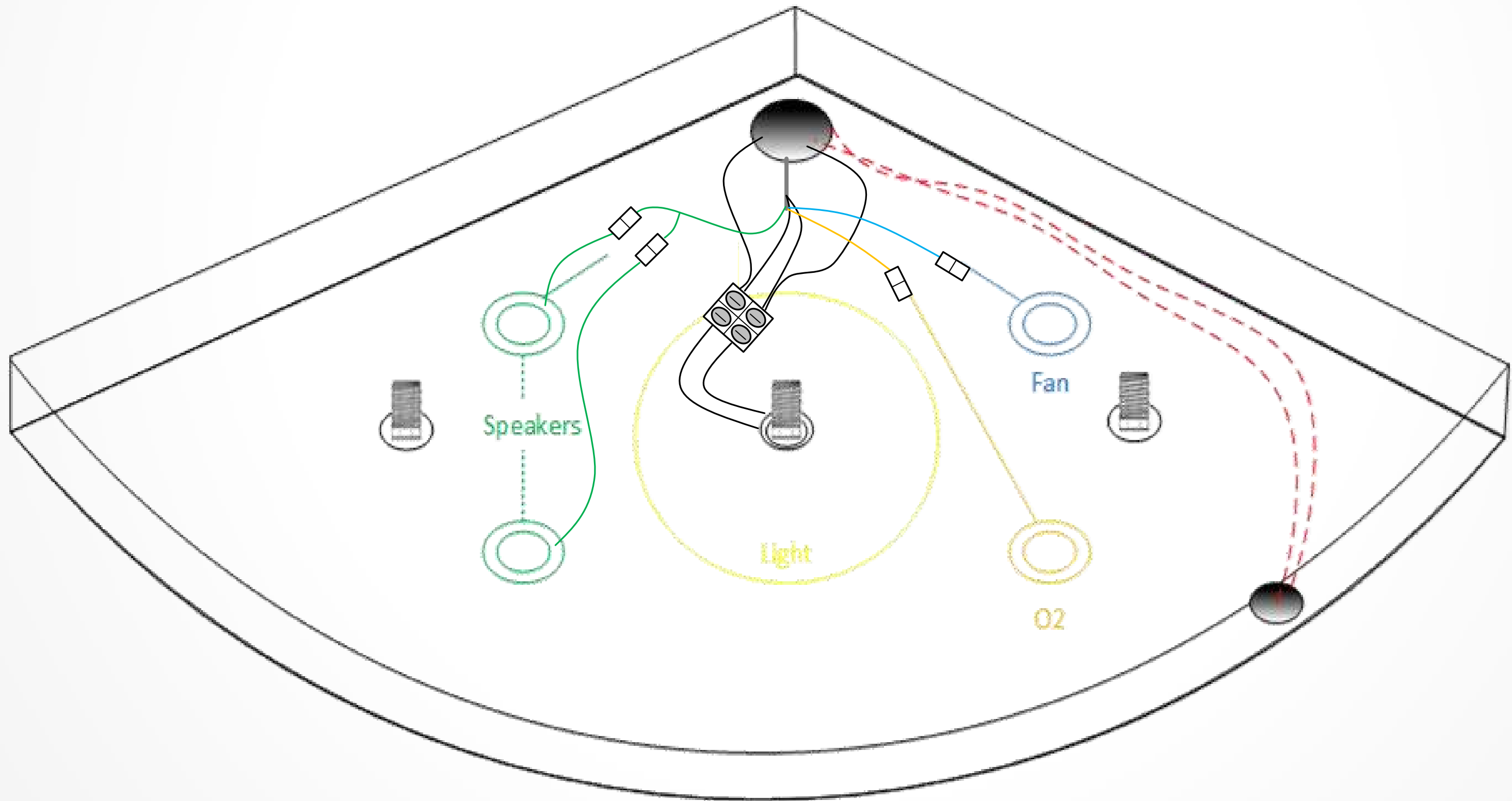

Cont. Light Connections

Tools Needed: Small Philips Screw Driver

The lights will have a 4 bar screw connector.

On the back of the Main Shower panel is two cables one coming from each of the LED lights on the main shower panel.

Run these cable to the ceiling.

Using those two cables and the light cable coming from the top middle of the shower, hold all of the solid red lines in one hand and twist them together. Then do the same thing separately to the red and black wires. When complete connect the wires inside the block matching the colors of the wires on the opposite side.

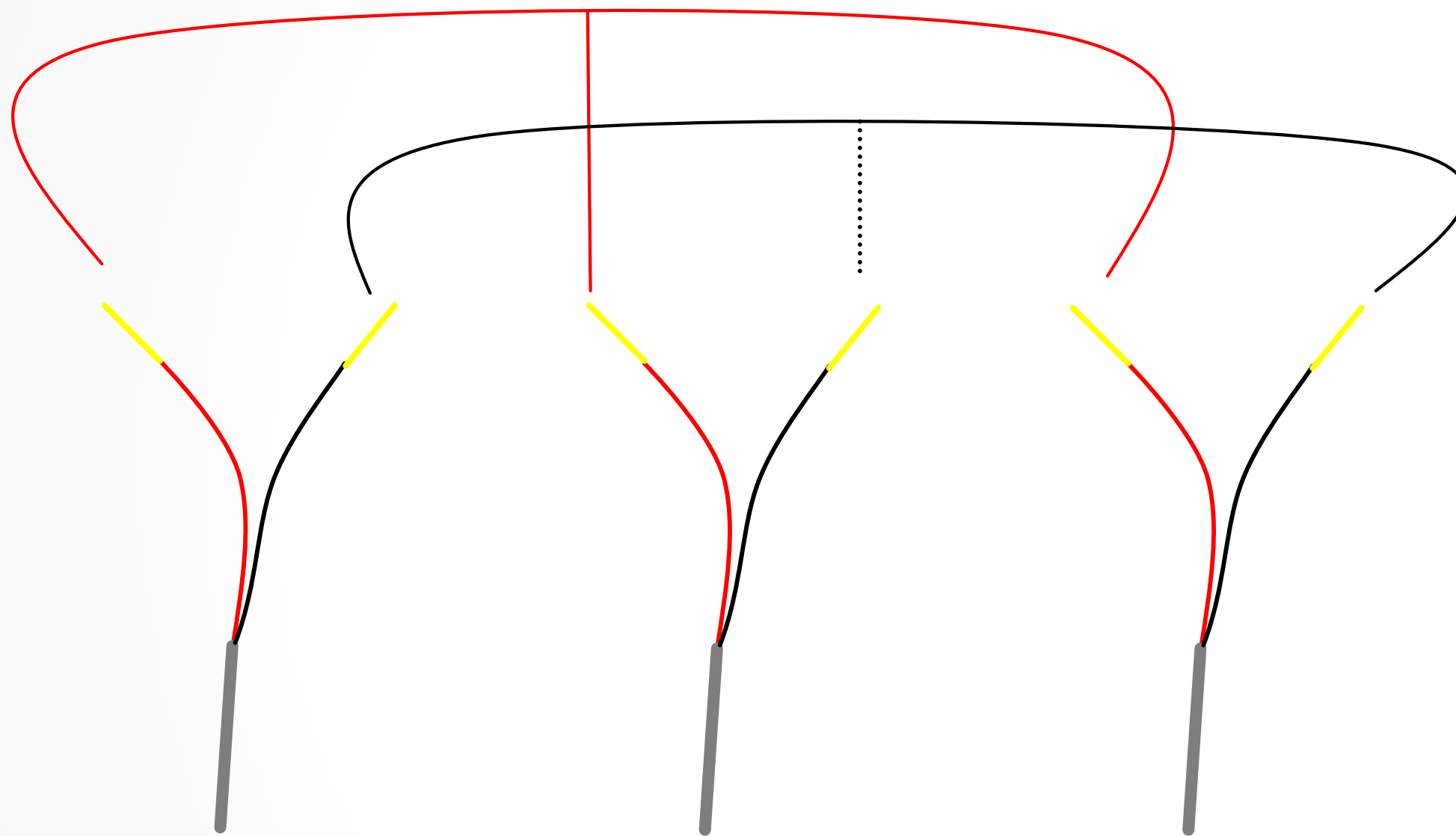

Cable from
LED Light on
back of main
shower panel

Cable from
LED Light on
back of main
shower panel

Cable from
LED Light on
top of shower
ceiling

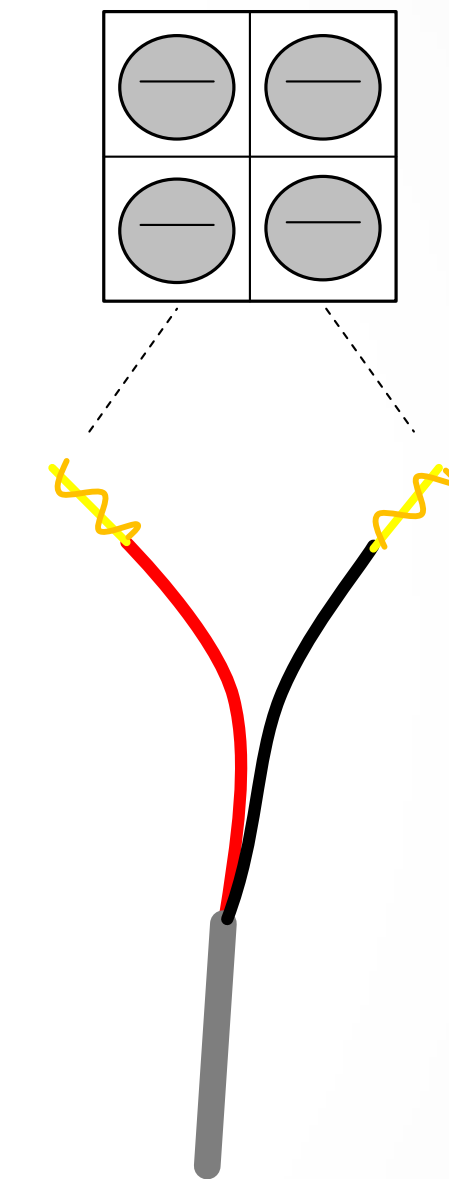

All three
cables twisted
together

Note 1 Water Valve Identification

Tools Needed: N/A

IF YOUR DIAL DOES NOT CORRESPOND TO THE APPROPRIATE DEVICE:

Turn on your water to the shower and note which output the water exits from then turn off the water and swap over the relevant hose.

Alternatively remove the outer chrome knob by removing the chrome cap and loosening the grub screw (please ensure not to unscrew fully as this will drop within the chrome knob) this is found on the opposite side to the chrome pillar.

Once you have succeeded in loosening this you can now slide your faceplate to correspond to the device.

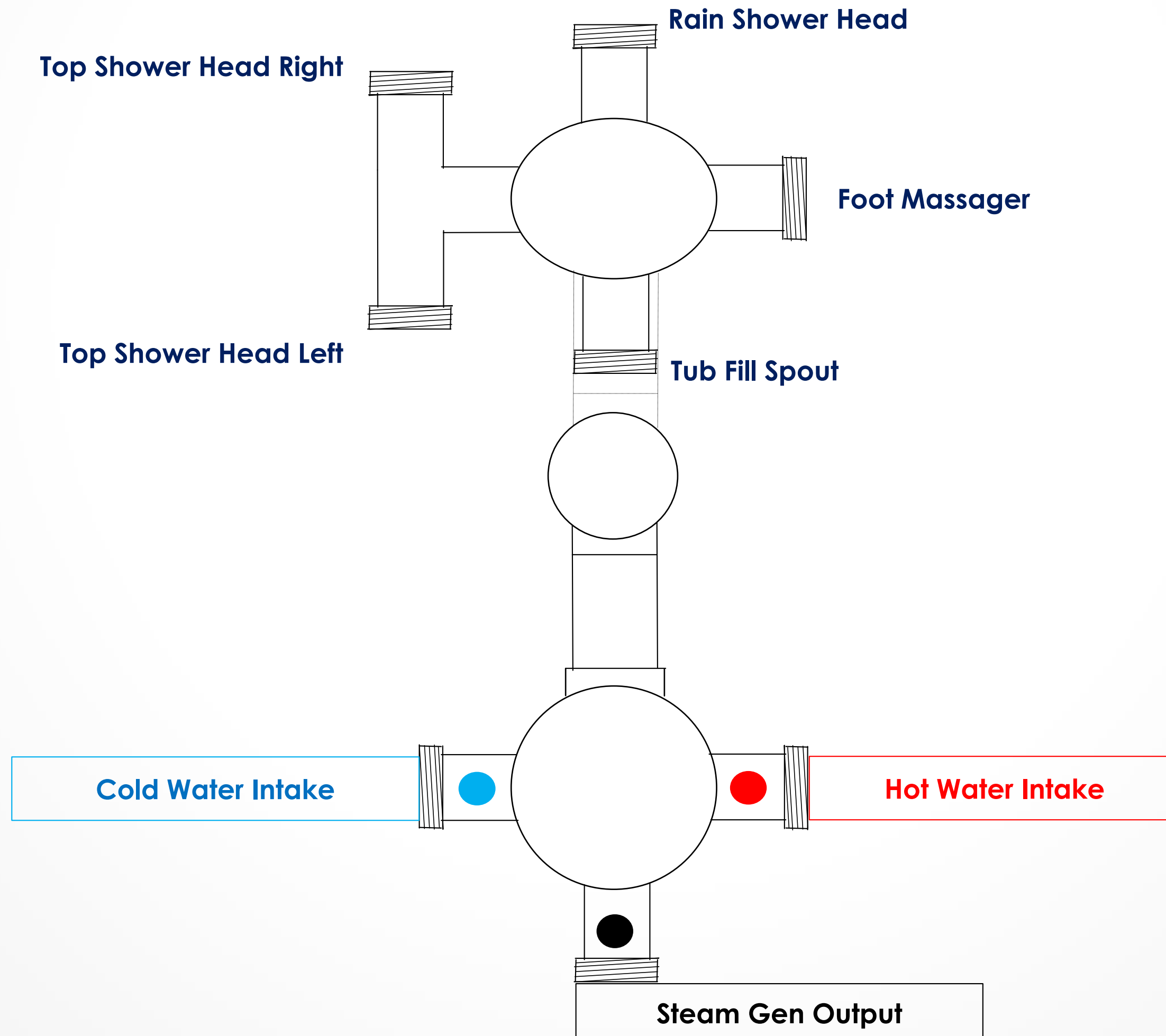

TESTING FOR WATER LEAKS

DO NOT USE SHOWER 24 HOURS AFTER BUILD TO ALLOW SEALANT TO CURE

With all connections tight, the waste and hoses checked, jets fully sealed, your shower still around 18 inches from its designated final resting point and the silicone fully cured (hence leaving for 24 hours minimum) Switch on the overhead shower NOT the massage jets, remember these will fire water out at you and are not suitable for checking leaks as they would normally only operate when a person is in front of them. Just use COLD water setting as hot will make cabin misty and condensate thus the inspection becomes very difficult. Now on the OUTSIDE of the shower inspect each joint, factory seal, hose, clip and jet by walking from one side and going around to the back and then to the other side finishing at the front. If you have a small leak (normally caused through insufficient sealer or air bubble on assembly, dry the area thoroughly and reseal on the OUTSIDE. Please remember where you see the water this may not be exactly where the leak is as it could have run around to a low point. Never seal your inner fittings (accessories) inside unless you feel it necessary and make sure it is thin and neat, remember you will see this for the life of the shower!

Again leave to cure and check. If all good now check shower functions i.e. jets for back massage, foot massage, (if you have one) and finally hand shower, check your joints to these functions at the rear again. Never use the shower until all checks have been made and the installer is 100% happy in the knowledge no leaks are present. All good?

Now push your shower FROM THE BASE NEVER PUSH FROM THE GLASS OR FRAME into its final resting position. Now you can shower in the knowledge that you have no leaks a job done well and long product life.

Happy showering!

Need Help
