

ANZZI™

SHOWER DOOR INSTALLATION

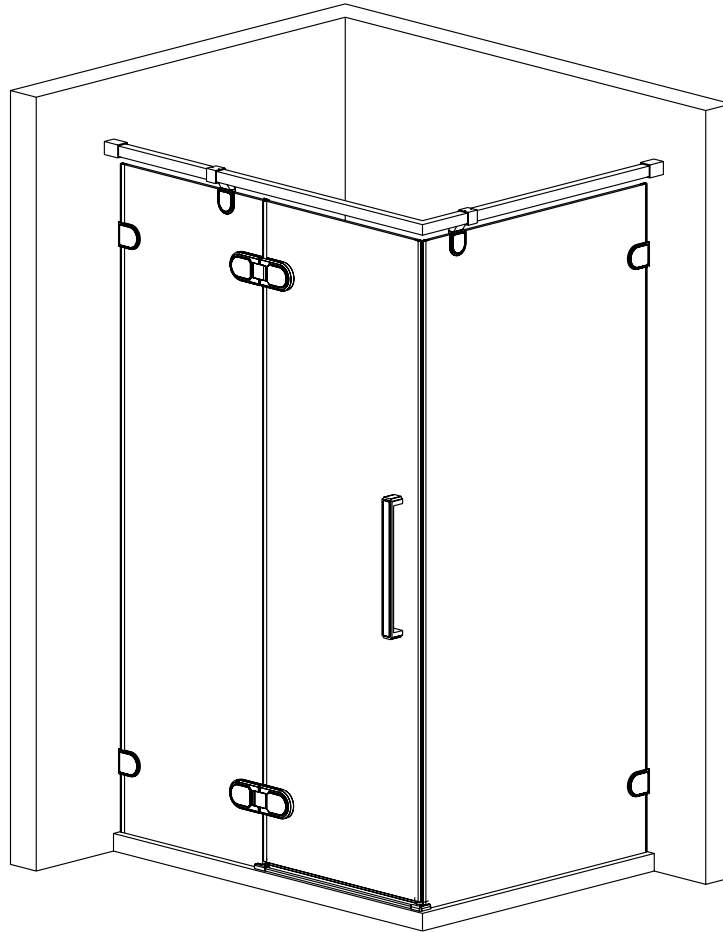

For models:
SD-AZ21



Please Note: This is a two person job. The glass doors are extremely heavy and it is highly recommended to use professional installers.

Preparation

1. After opening all boxes and packages, read this introduction carefully. Check that all of the needed parts are included in the package, by marking all the components on the "Detailed Diagram of Tub Door Components". Examine boxes and packages for shipping damage. If the unit has been damaged, has a finishing defect, or has missing parts, please contact our customer support department within 3 business days of the delivery date.
2. If this unit is going to be installed in a new construction, please, install all of the required plumbing and drainage before installing the shower. **Use a competent and licensed (if required by local code) plumber for all plumbing installation**
3. **Please note that you should consult your local building codes with questions on installation compliance standards. Building and plumbing codes may vary by location, and we will be not responsible for code compliance standards for your project.**
4. Please insure that prior to the installation the installation surface is leveled and solid and will be able to support the total weight of the unit. Also make sure the walls are at right angles. While some adjustment in leveling of the door is possible, irregular installation surface level or improper angle of side walls will result in serious problems for your installation. Please, note that some adjustments and drilling might be necessary during the installation process.

Tools Required

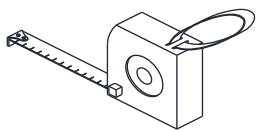

Tape Measure



Pencil



Phillips Screwdriver

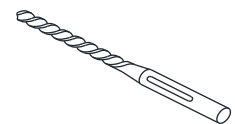

Drill bit
(Ø 5/16")



Level

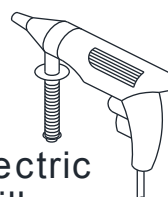







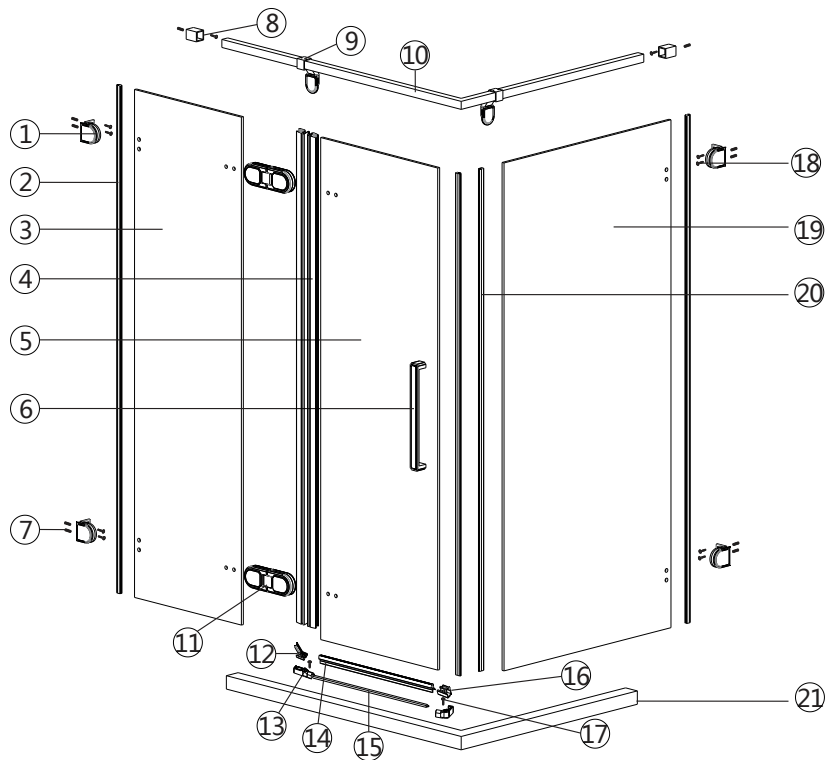













Electric Drill



Hammer



No.	Description	Drawing	Qty	No.	Description	Drawing	Qty	No.	Description	Drawing	Qty
1	Wall clip		4	9	Bracket		2	17	ST4*12		2
2	Rubber seal		2	10	Square bar		1	18	ST4*30		10
3	Fixed glass panel		1	11	Hinge		2	19	Side fixed glass panel		1
4	Side water guard		1	12	Drainer		1	20	Magnetic seal		2
5	Moving glass panel		1	13	water guard joint		2	21	Base		1
6	Handle		1	14	Bottom water guard		1				
7	Wall anchor		10	15	Water guard		1				
8	Wall fixing base		2	16	Drainer		1				

NOTE: Unpack your unit carefully and inspect it. Lay it out and identify all parts using the detailed diagram and packing list in your manual as a reference. Before discarding the carton, check for small hardware bags that tend to fall to the bottom of the box. If any parts are damaged or missing, please contact us.

Installation steps:

1. Installation of base:

- ①.lay down base.
- ②.check base level,keep it fully flat by padding or rubbing.

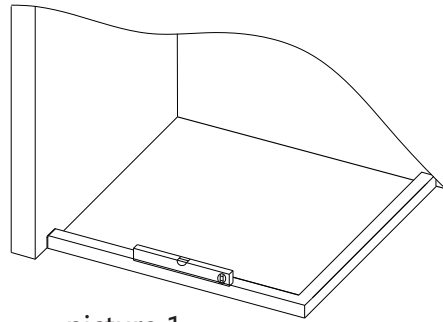

picture 1

2.Installation of fixing clip

- ①.as picture 2: install fixing clip on the fixed glass panel then install rubber seal

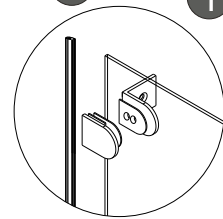
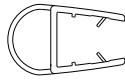

1

2

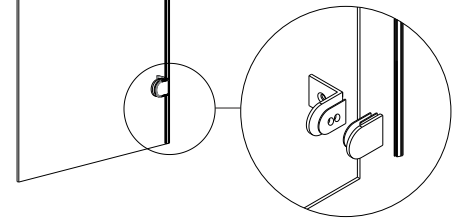
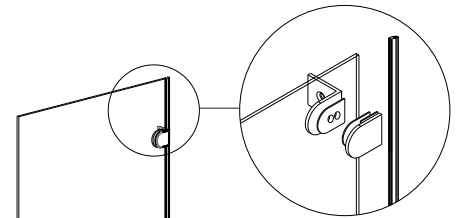
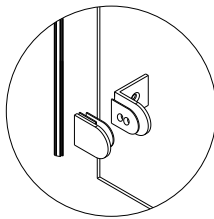

picture 2

3. Drawing and drilling hole

- ①.as picture3: put front fixed glass panel on the base,check 100% level, mark installation and drilling hole on the wall for fixing clip, drill hole with $\Phi 6$ drill

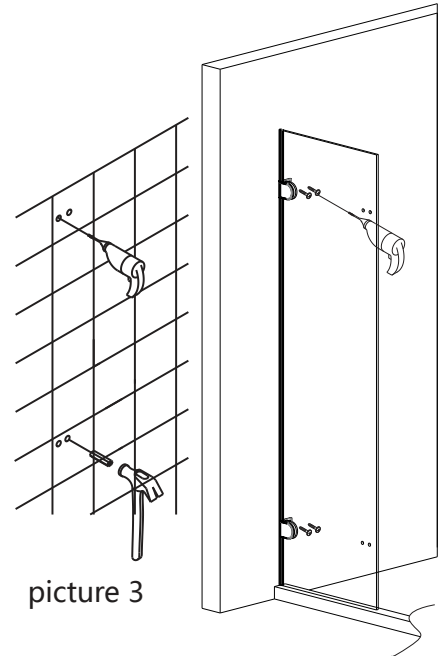
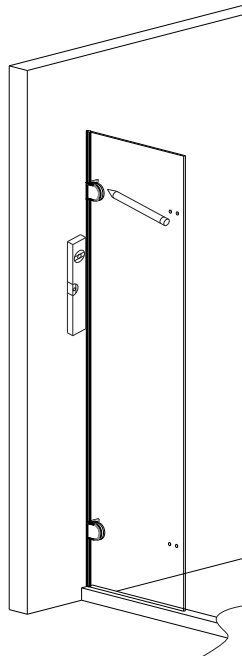

picture 3

4. Installation of hinge and handle

- ①.as picture 4: fix hinge on the fixed glass panel, then install moving glass panel on 66 hinge.
- ②.as picture A: install 66 handle

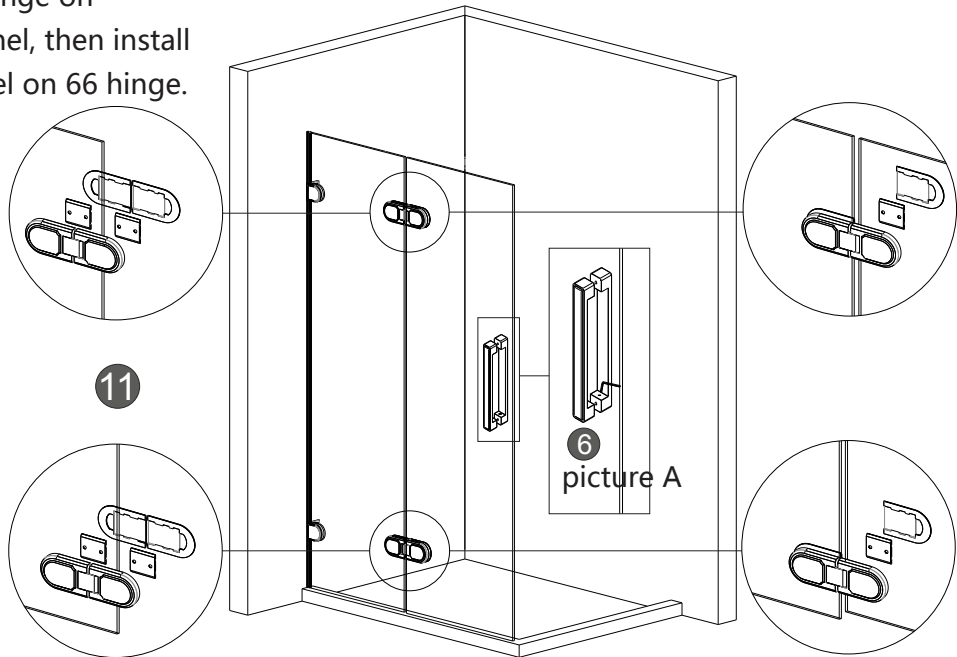

picture 4

5. Installation and adjustment of magnetic seal, rubber strip, side fixed glass panel

- ①.as picture B: install rubber strip, magnetic seal.
- ②.as picture 5: put side fixed glass panel on the base, check 100% level, mark installation and drilling hole on the wall for fixing clip, drill hole with $\Phi 6$ drill
- ③.as picture C: after installation, check the matching of door and magnetic seal, adjust it if any problem.

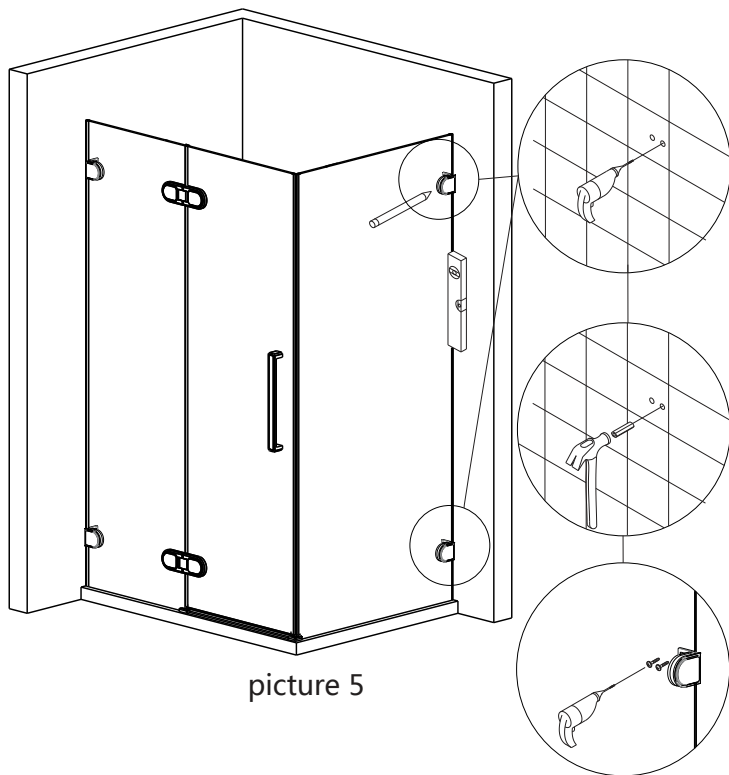
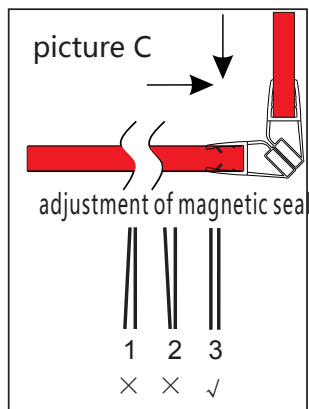
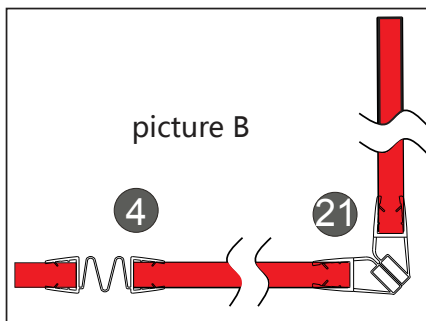

picture 5

6. Installation of frame ,water guard(alluminium),bottom water guard,drainer

- ① as picture 6 : fix into square bar, then insert into wall fixing base.
- ② as picture 6:install assembled bar on glass panel,fix hole for wall fixing base with pencil.
- ③ as picture D:install bottom water guard
- ④ as picture 6: install water guard joint and water guard (alluminium)
- ⑤ as picture 6: install drainer

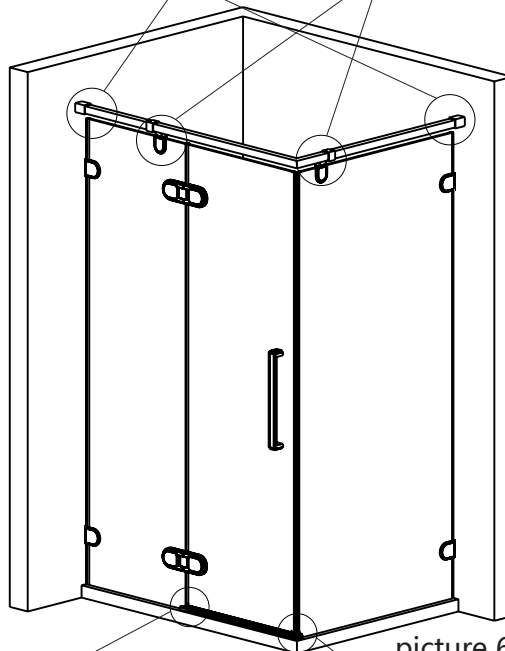
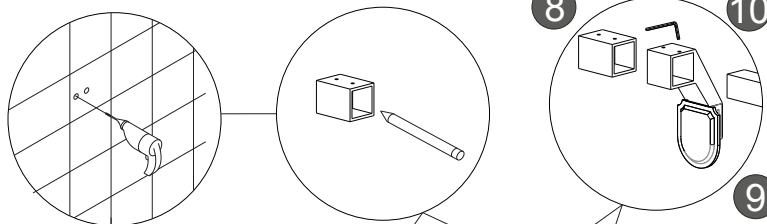
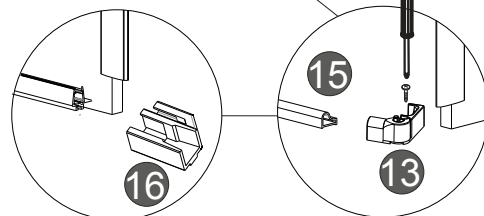
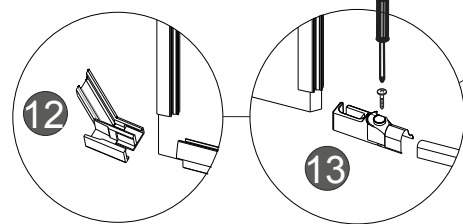
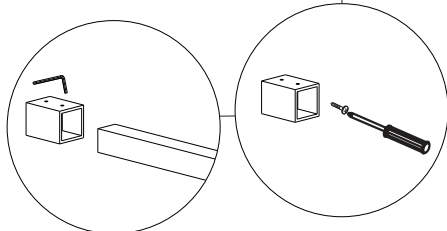
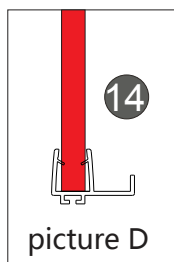

picture 6

7. Painting glass glue:

- ① as picture 7 : paint glass glue between glass panel and wall for seal

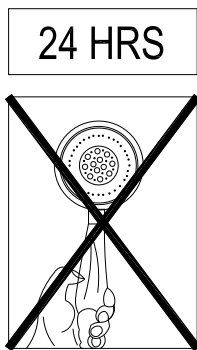

Do not use it in 24 hours after glass glue is painted,Ensure the glue is fully dried before using.

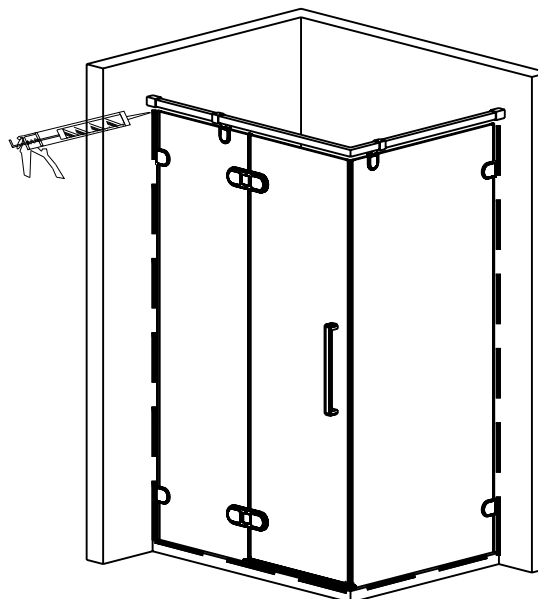

picture 7