



Bolden™ Single Handle Commercial Kitchen Faucet

KPF-1610

Congratulations on the purchase of your new Kraus® plumbing fixture!

Please keep the box and packaging materials until your product is completely installed. If you have any questions, require technical assistance or have any problems with your product:



DO NOT RETURN TO STORE

**Please contact our Customer Service Team
1-800-775-0703 / customerservice@kraususa.com**

Have the model number available and retain a copy of your receipt with purchase date for reference.

If for any reason this product does not meet your expectations, please be sure to repack this product in the original box and packaging material to avoid damage during transit.



Prior to Installation:

- Make sure you have all necessary parts by checking the diagram and parts list. If any part is missing or damaged, please contact Kraus® Customer Service at 800-775-0703 for a replacement.
- Read all instructions and safety warnings and ensure you have all tools, parts, and equipment necessary for a safe installation.
- Turn off the hot and cold water supply at the angle stops and turn on the old faucet to release any built up pressure. Remove existing faucet. Clean sink or countertop to remove any debris, plumber's putty, or silicone.
- Flush angle stops to release any debris prior to installation.
- Pre-drilled hole size requirement: 1 3/8" (min)
- Max countertop thickness: 2 1/2"
- 1, 2 or 3 hole installation with optional deck plate (sold separately)

Tools Required

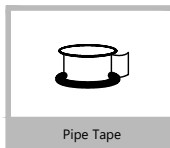
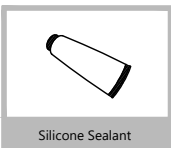
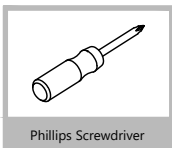
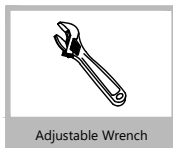

Care & Maintenance

To keep the product clean & shining, follow the steps below:

1. Rinse with clean water & dry with a soft cloth
2. Do not clean with soaps, acid, polish, abrasives or harsh cleaners
3. Do not use cloth with a coarse surface
4. Unscrew the aerator and clean when necessary



This installation manual is subject to change without further notice.

Diagram and Parts List

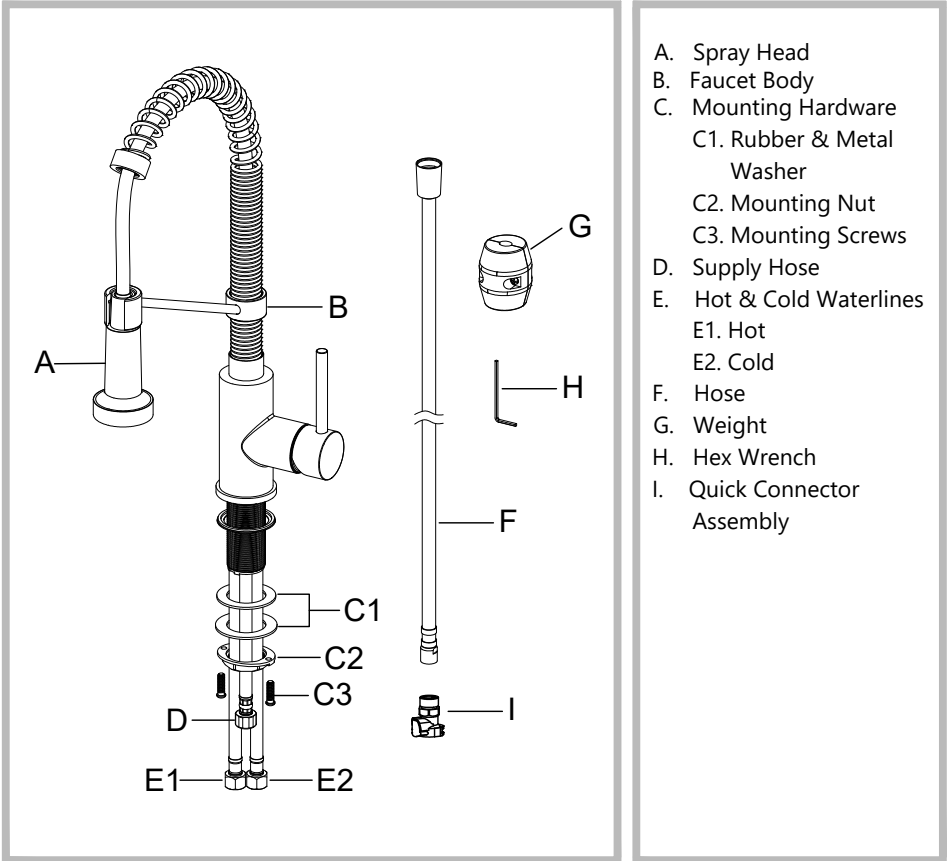

For technical assistance or replacement parts, please contact Kraus®

Customer Service and one of our representatives will be happy to help:

Toll-Free: 800-775-0703 or customerservice@kraususa.com

Faucet Dimension

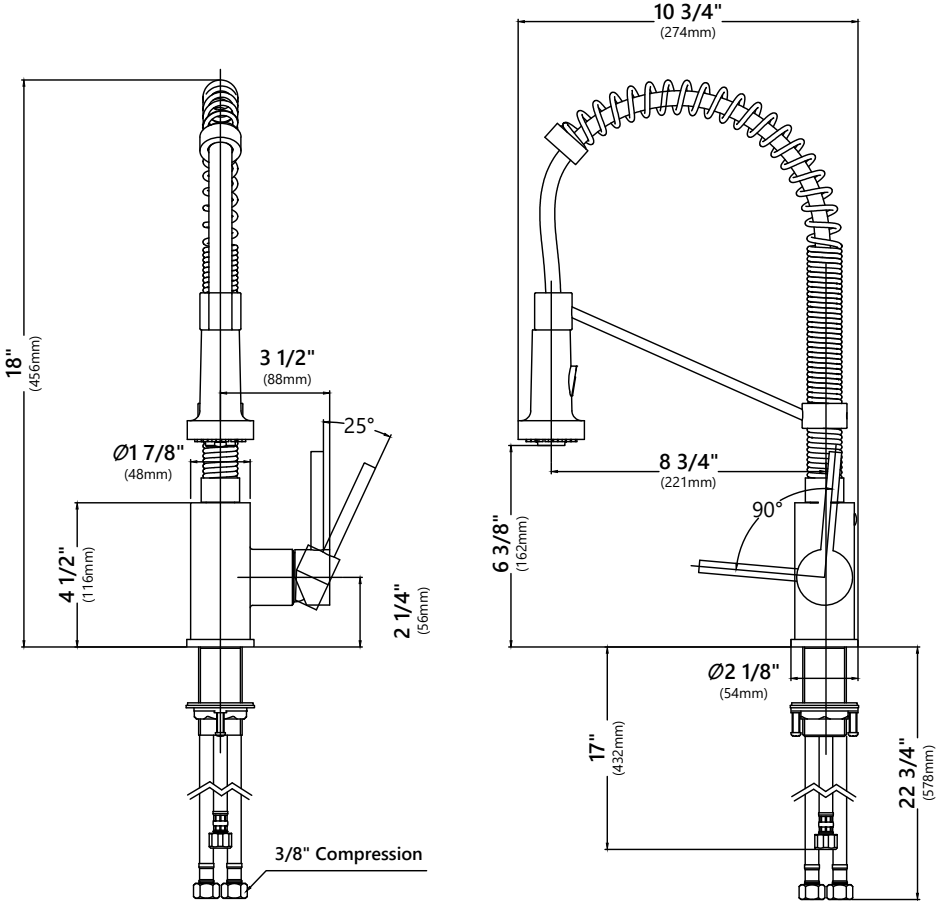

Installer Tip:

Shut off main water supply before installing new faucet.

Step 1. Remove mounting hardware

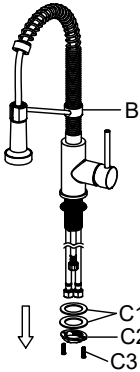

Remove mounting hardware (C1, C2 & C3) from faucet body (B).

Step 2. Install the faucet and mounting hardware

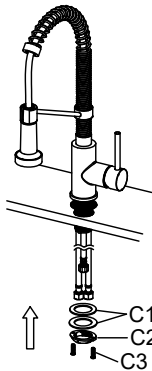

Insert faucet body through the hole in the sink or countertop. Install the rubber washer and metal washer (C1), mounting nut (C2) and mounting screws (C3) onto the threaded mounting shank.

Step 3. Secure mounting hardware

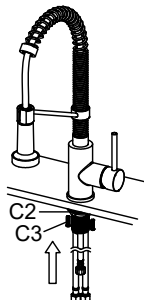

Thread the nut (C2) onto the mounting shank. Lock the nut (C2) into position by tightening the screws (C3). Do not overtighten.

Step 4. Connect the quick connector

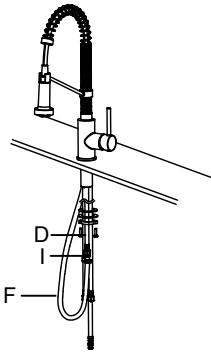

Connect the quick connector (I) to the supply hose (D) by twisting clockwise. Push the spray hose (F) firmly upward into quick connector. Pull down moderately to ensure the connection has been made.

Step 5. Attach the weight

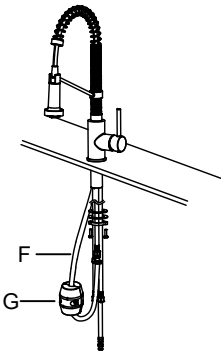

Install the weight (G) on the indicated mark on the spray hose (F).

Step 6. Making the waterline connections

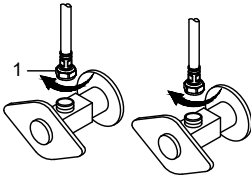

Thread the nut (1) on the supply line onto the outlet of the water supply valve and tighten with a wrench. Do not overtighten.

Step 7. Flushing and checking for leaks

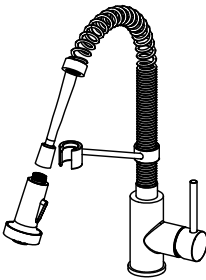

Pull the hose assembly out of the spout and remove the spray head by unscrewing it from the hose in a counterclockwise direction. Be sure to hold the end of the hose down into the sink and turn the faucet on to the warm position where it mixes hot and cold water. Flush the water lines for one minute. This flushes away any debris that could cause damage to internal parts. Check for leaks. Re-tighten any connections if necessary, but do not overtighten. Reinstall the spray head by hand tightening it back onto the spray hose. After installation is completed, turn on the hot and cold water supplies. Check for leaks.

Replacement Parts

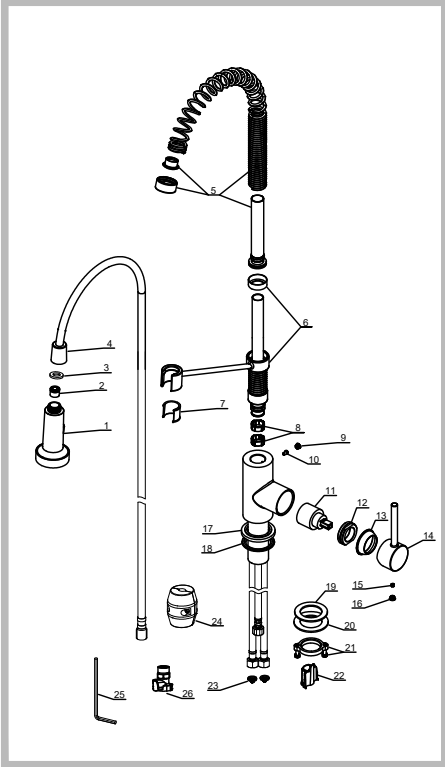

*Denotes spray hose assembly color options:
 Spray hose assembly color options: Black hose with Matte Black connector (BLMB), Black hose with Stainless Steel connector (BLSS), Gray hose with Chrome connector (GRCH), Gray hose with Stainless Steel connector (GRSS), Black hose with Spot Free Stainless Steel connector (BLSFS), Gray hose with Spot Free Stainless Steel connector (GRSFS)

**Denotes faucet component color options:
 CH - Chrome
 SS - Stainless Steel
 MB - Matte Black
 SSCH - Stainless Steel/Chrome
 SSMB - Stainless Steel/Matte Black
 SFS - Spot Free Stainless Steel
 SFSCH - Spot Free Stainless Steel/Chrome
 SFSMB - Spot Free Stainless Steel/Matte Black

Replacement Parts List	Finish/Color	Part #
1. Spray Head	CH,SS,MB,SFS**	KP12202
2. Check Valve		KP12003
3. Washer		KP12205
4. Hose	GRCH, GRSS, GRSFS, BLSFS, BLSS, BLMB*	KP12204
5. Spring Assembly	CH,SS,MB,SFS**	KP12189
6. Sprayer Support Assembly	CH,SS,SFS,MB, SFSCH, SFSMB, SSCH, SSMB**	KP12206
7. Hose Guide		KP12203
8. Sleeve		KP12008
9. Cap	CH,SS,MB,SFS**	KP12009
10. Set Screw		KP12010
11. Cartridge		KP12015
12. Locking Nut		KP12014
13. Cartridge Cover	CH,SS,MB,SFS**	KP12013
14. Handle	CH,SS,MB,SFS**	KP12011
15. Handle Set Screw		KP12012
16. Cap	CH,SS,MB,SFS**	KP12009
17. Base	CH,SS,MB,SFS**	KP12016
18. Base O-ring		KP12122
19. Rubber Washer		KP12018
20. Metal Washer		KP12019
21. Mounting Nut & Screws		KP12020
22. Protective Sleeve		KP12021
23. Filter Washers		KP12026
24. Weight		KP12024
25. Hex Wrench		KP12028
26. Quick Connector Assembly		KP12201

Troubleshooting

If you have followed the instructions carefully and your faucet still does not work properly, take the following corrective steps:

PROBLEM	CAUSE	ACTION
Leakage under faucet handle	Locking nut has come loose or cartridge needs to be reseated	Loosen the set screw located at the base of the handle with a hex wrench. Remove the handle and unscrew cartridge holder by hand. Tighten locking nut with an adjustable wrench.
The aerator has an irregular or reduced water flow	The aerator is dirty or mis-fitted	Remove the aerator and check for debris. Ensure that the rubber washer is properly installed.
The water pressure is low.	The connector underneath the deck is clogged with debris The aerator is clogged	Turn off the water supply and disconnect the connector / aerator. Unscrew the connector / aerator and clean under running water. Screw the connector / aerator back. Test water flow. If water pressure is still low then replace the connector / aerator.
There is a low flow of water.	The screen filter in the hose connectors is dirty.	Turn off the water supply at water valve and unscrew the hose connectors from water supply lines. Clean the screen in the water lines with hot water, removing any debris or calcium build up.

Codes/Standards Applicable:



ASME A112.18.1
1.8GPM 6.8L/min maximum

Faucet

Kraus USA Plumbing, LLC ("Kraus") extends this warranty to the original purchaser for personal household use of the Faucet when purchased from an authorized Kraus dealer and in the location of original installation. This warranty is non-transferable.

Kraus warrants the structure and finish of the Faucet to be free from defects in material and workmanship under normal usage for as long as the original purchaser resides in the residence in which the Faucet was first installed.

Kraus warrants the Faucet's sprayhead assembly (including the engine, aerators, structure, restrictors, back flow preventers, sprayer hoses, braided supply line hoses which encompasses nylon, silicon and stainless steel) of the product to be free from defects in material and workmanship under normal usage for a period of one (1) year from the date of purchase.

Kraus warrants the Faucet's cartridge to be free from defects in material and workmanship under normal usage for a period of five (5) years from the date of purchase.

Any product reported to the authorized dealer or to Kraus as being defective within the warranty period will be repaired or replaced with a product of equal value at the option of Kraus.

Commercial Warranty

Kraus USA Plumbing, LLC ("Kraus") warrants its Products for a period of one (1) year to commercial purchasers of Products used in industrial, commercial and business applications.

Care and Cleaning Instructions

Certain cleaning products may cause damage to a Product's finish and use of the following on the Product will void this warranty:

- Abrasive cleaners such as powders, bleach, ammonia, alcohol or chlorine
- Abrasive pads, steel wool or wire brushes

What is Not Covered

This warranty does not cover Products that were discontinued when purchased or display Products, whether such Products were purchased at discount outlets, unauthorized dealers, and/or sold on clearance. This warranty does not cover any free gifts included with purchase.

This warranty does not cover damage resulting from neglect, misuse (including use for an unintended application), abuse, carelessness, accident, hard water or mineral deposits, exposure to corrosive materials, improper maintenance, alteration of the Product, or failure to follow care, cleaning or installation instructions enclosed with your Product. Kraus recommends that all Kraus Products be installed by a fully licensed and insured trade professional with experience in the installation of bathroom and/or kitchen manufactured goods.

How to Make a Warranty Claim

If you are a **consumer purchaser**, please contact a Kraus Customer Service Representative at:
Kraus USA Plumbing, LLC
12 Harbor Park Drive
Port Washington, NY 11050
Toll-free 800-775-0703
Customerservice@kraususa.com

If you are a **plumbing contractor or trade professional**, please contact a Kraus Pro Representative at:
Kraus USA Plumbing, LLC
12 Harbor Park Drive
Port Washington, NY 11050
516-801-8955
Proservice@kraususa.com

If you are an **authorized partner**, please contact a Partner Support Representative at:
Kraus USA Plumbing, LLC
12 Harbor Park Drive
Port Washington, NY 11050
516-801-8954
Partnersupport@kraususa.com

In requesting warranty service, please be ready to provide your proof of purchase and a description of the problem. Shipping charges will be covered for the first (1) year of the warranted replacement part or product (HI, AK, and Puerto Rico shipping charges may apply). International shipping fees are not included.

Limitation on Duration of Implied Warranties

Please note that some states/provinces (including Quebec) do not allow limitations on how long an implied warranty lasts, so the below limitations may not apply to you. TO THE MAXIMUM EXTENT PERMITTED BY APPLICABLE LAW, ANY IMPLIED WARRANTY, INCLUDING THE IMPLIED WARRANTIES OF MERCHANTABILITY AND OF FITNESS FOR A PARTICULAR PURPOSE, IS LIMITED TO THE STATUTORY PERIOD OR THE DURATION OF THIS WARRANTY, WHICHEVER IS SHORTER.

Limitation of Special, Incidental or Consequential Damages

Please note that some states/provinces (including Quebec) do not allow the exclusion or limitation of special, incidental or consequential damages, so the below limitations and exclusions may not apply to you. TO THE MAXIMUM EXTENT PERMITTED BY APPLICABLE LAW, THIS WARRANTY DOES NOT COVER, AND KRAUS USA PLUMBING, LLC SHALL NOT BE LIABLE FOR, ANY SPECIAL, INCIDENTAL OR CONSEQUENTIAL DAMAGES (INCLUDING LABOR CHARGES TO REPAIR, REPLACE, INSTALL OR REMOVE THIS PRODUCT), WHETHER ARISING OUT OF BREACH OF ANY EXPRESS OR IMPLIED WARRANTY, BREACH OF CONTRACT, TORT, OR OTHERWISE.

This warranty gives you specific legal rights, and you may also have other rights which vary from state/province to state/province.

Download the Kraus Care & Maintenance Guide at:
<http://www.kraususa.com/maintenance>

IMPORTANT

Register Your Kraus Product

Activate Your Warranty

Access Premium Customer Support

Get Product Information

REGISTER TODAY

<http://www.kraususa.com/registration>



Kräus[®]
www.kraususa.com