

DE LUSSO DL30

Sink: DL30SINK

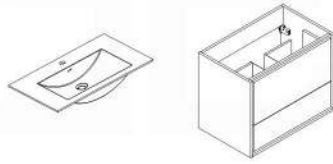

Dimensions:	width	depth	height
inches	29.8"	18.5"	23.3"
mm	756	470	592

NOTE: DIMENSIONS AND TECHNICAL DETAILS ARE SUBJECT TO CHANGE WITHOUT NOTICE

FRONT ELEVATION

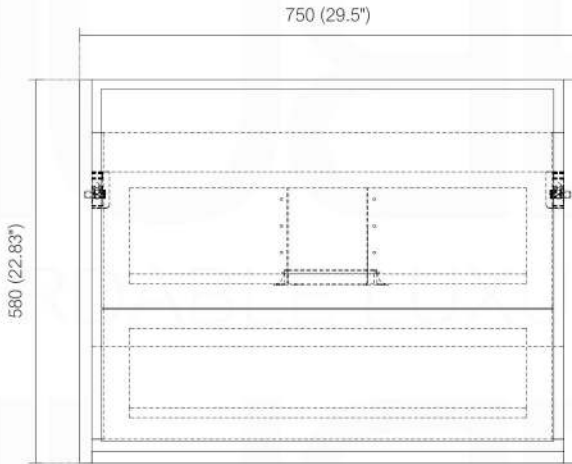

SIDE ELEVATION

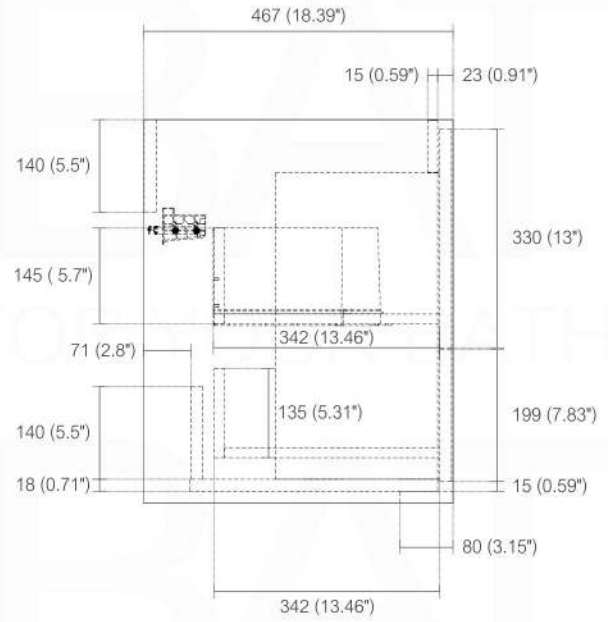

TOP ELEVATION

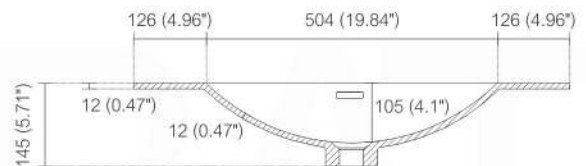
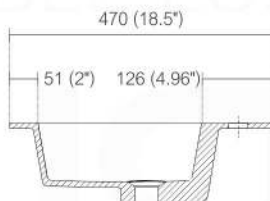
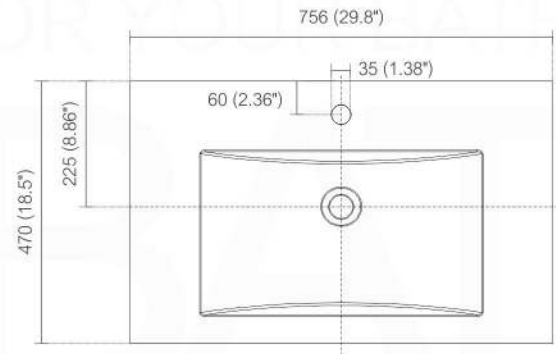
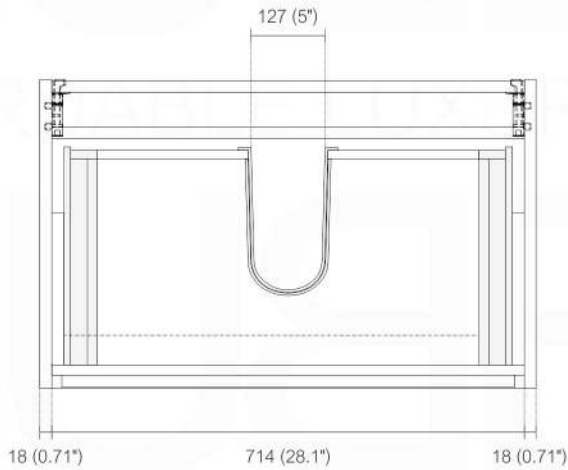

How to Install a De Lusso Vanity INSTALLATION GUIDE

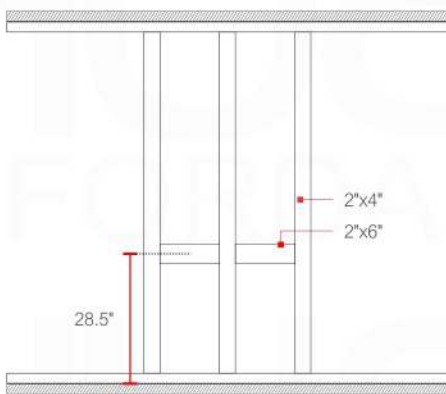
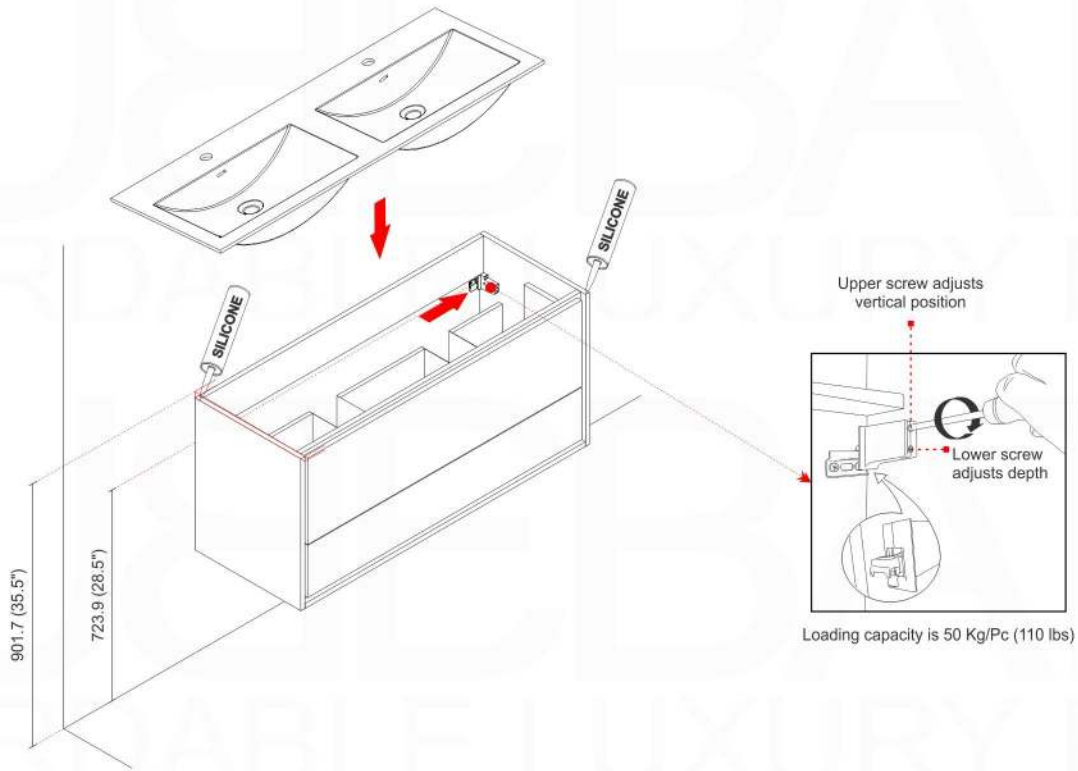

1. Determine your vanity placement and mark the area on the wall where it will be installed.
2. Install 2"x6" lumber between the wall studs, behind the drywall. Suggested distance from finished floor will be 28.5" to the center of the floor if the desired finished height of the Vanity is 35.5" from the floor to the top of the finished countertop.
3. If your vanity cabinet has a solid back, mark and drill holes to accommodate drain pipes and supply pipes as necessary.
4. Mark the location of each of the wall mounting plates ensuring that they are positioned inside the sidewalls of the vanity unit. 
5. Place the vanity in the installation location. Verify that the vanity cabinet is level.
6. Install the integral sink/vanity top by applying a dot of silicone sealant on the corners of the vanity. Position the vanity top onto the vanity and press firmly into place. Wipe away any excess sealant with a damp cloth.

Note: We recommend consulting professional help if you are unfamiliar with installing bathroom vanities and/or plumbing.

Vanity cabinet | removing+adjustment drawers

To remove the drawer/s

- * Extend the drawer
- * Each drawer has a **plastic cover plate** on each side of the drawer (#1 and #2)
- * **Remove both cover plates (#1 and #2)** to expose a small **drawer release lever** under each plate: see detail
- * To release and remove the drawer, simultaneously **push the drawer release levers upwards** (both sides at same time) and slide/lift the drawer away from the tracks. Repeat for each drawer.

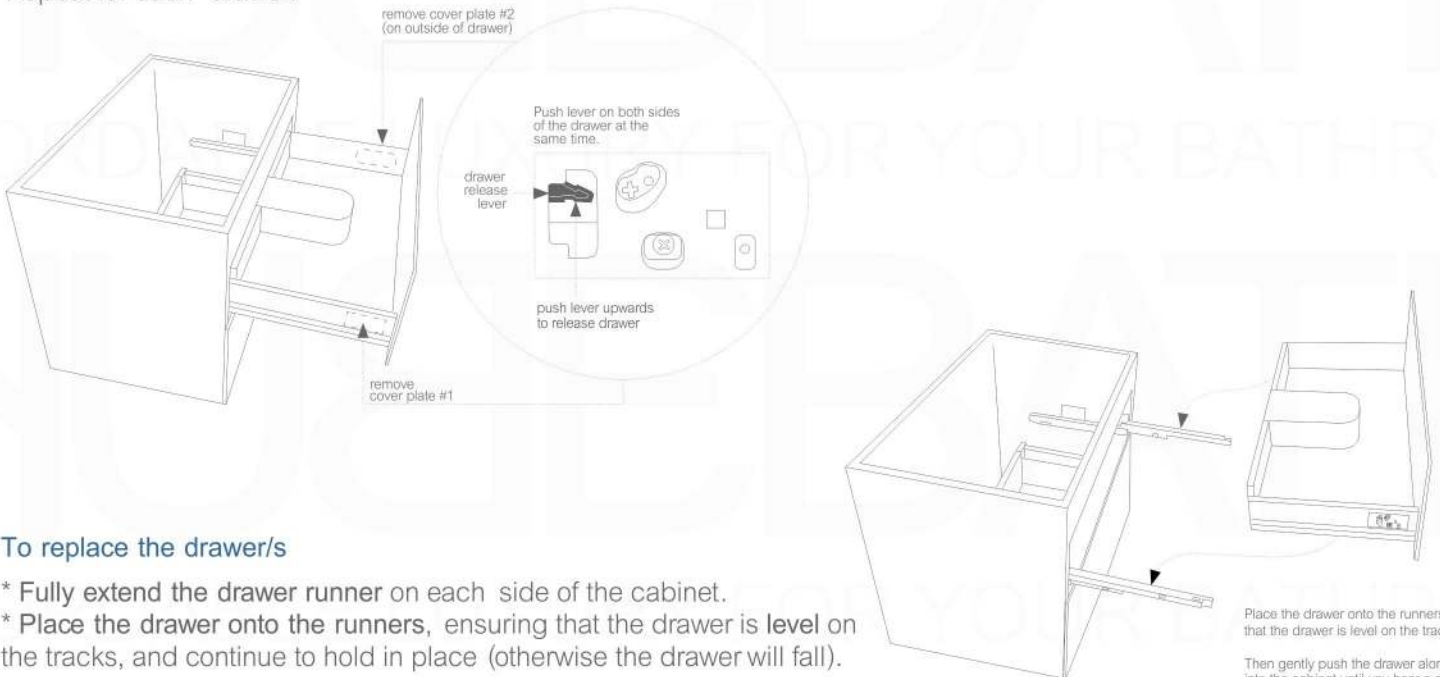

To replace the drawer/s

- * Fully extend the drawer runner on each side of the cabinet.
- * **Place the drawer onto the runners**, ensuring that the drawer is **level** on the tracks, and continue to hold in place (otherwise the drawer will fall).
- * Keeping the drawer level, gently **push the drawer along the runners into the cabinet until you hear a click**. This indicates that the drawer is properly locked into place on the track.
- * Once the drawer is back in place, replace the cover plates on the sides of the drawer.

To adjust the drawer/s

- * To move the drawer up or down, turn the **bottom screw** located under the cover plate on each side of the drawer.

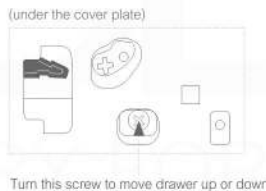

These instructions show a vanity cabinet which has two drawers. However, the instructions apply to all cabinets and all sizes of the Bliss Vanity line. The characteristics and drawer mechanisms are the **same** for all units.

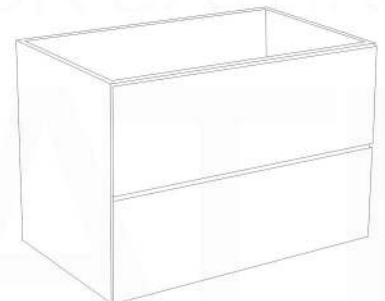

Pop-Up / P-trap Installation Instructions INSTALLATION GUIDE

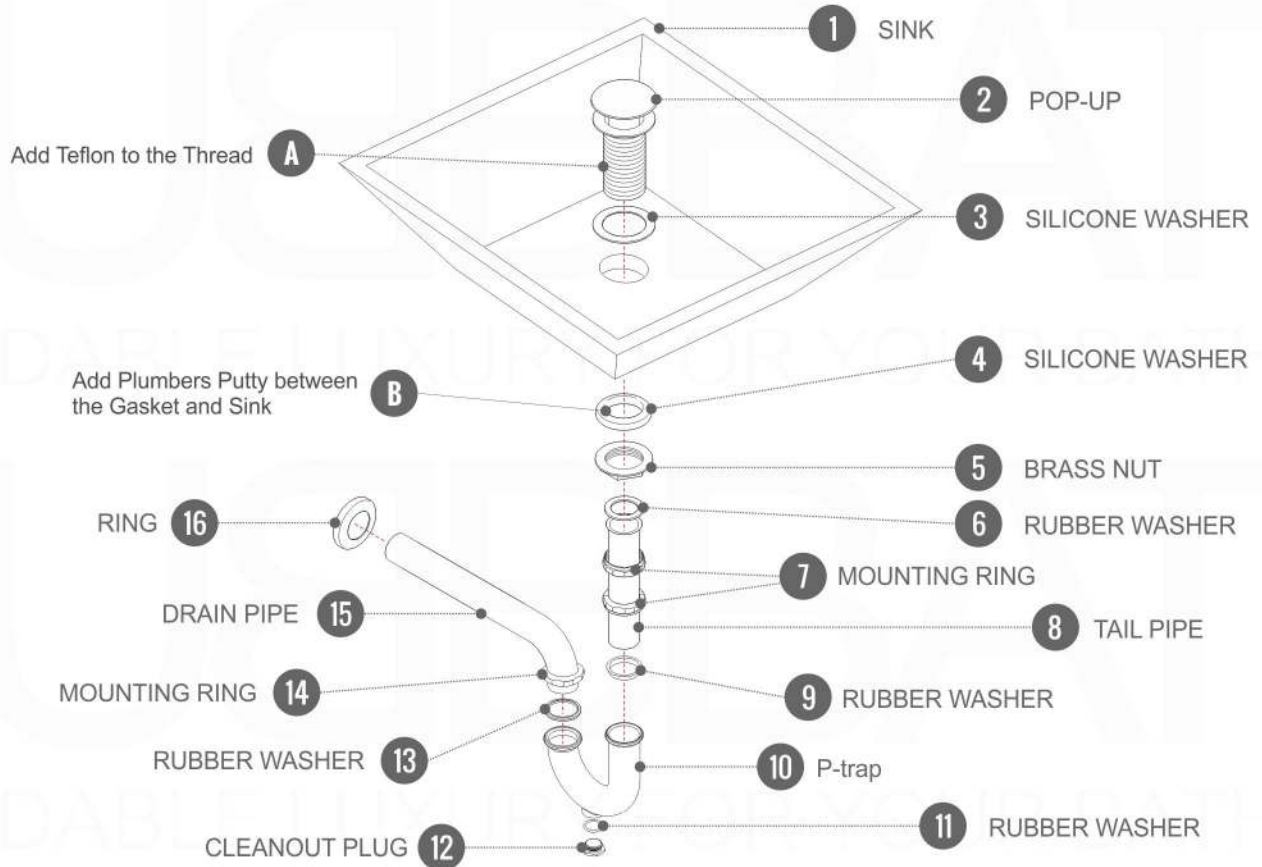

FOR SINKS WITHOUT OVERFLOW
#SKU: P101N / P102N

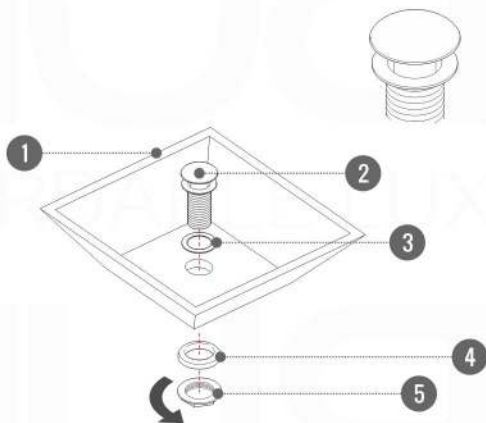

FOR SINKS WITHOUT OVERFLOW
#SKU: P101 / P102

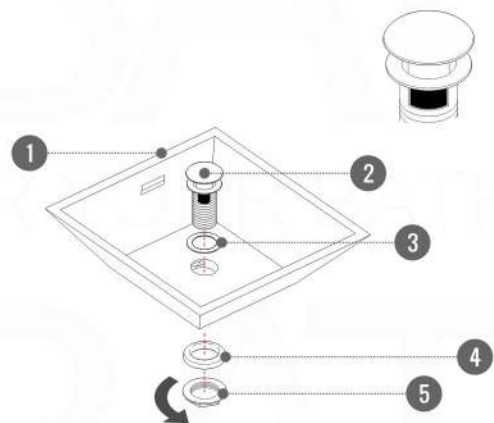

OR