

72" Emmeline Double Vanity

D100-V72-CSN

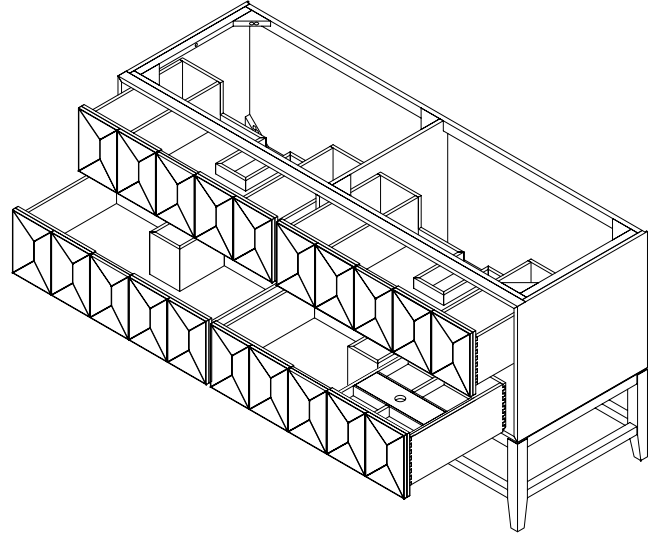
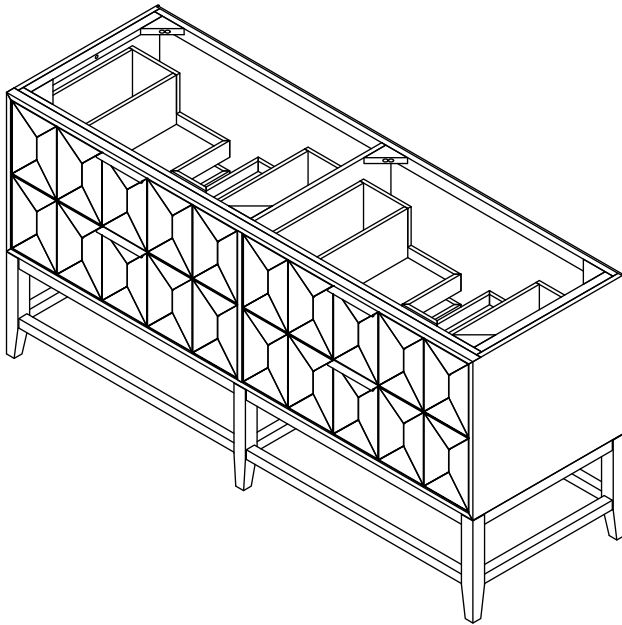

Details and Features

Solids: Ash
 Veneers: Ash
 Panels: Marine MDF
 Installation Type: Free-standing
 Number of Doors: 0
 Number of Drawers: 4
 Top Drawers: Left and Right Storage Compartments and center U-shaped tray style storage underneath the sink areas
 Bottom Drawers: U-Shaped drawers to accommodate plumbing
 Assembly Required: No
 Removable organizer with aluminum laminate liner
 Drawer Boxes: Ash veneer over Marine MDF
 English Dovetail joinery
 Aluminum Laminate Drawer Liners
 Hardware Finish: Champagne Brass
 Full Extension, Soft Close Glides
 Vanity Top: Not Included – Optional 3cm Tops available
 Number of Basins: 2
 (included with optional countertop purchase)

Dimensions

Width: 71-9/16" (1817mm)
 Depth: 23-1/4" (591mm)
 Height: 34-13/16" (884 mm)
 Rough-In: 21-11/16" (551mm)

Drawer Edge Pulls

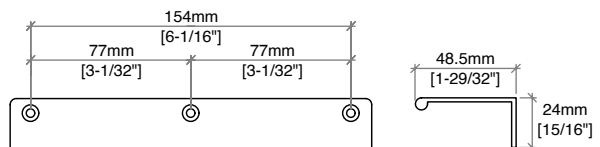

72" Emmeline Double Vanity

D100-V72-CSN

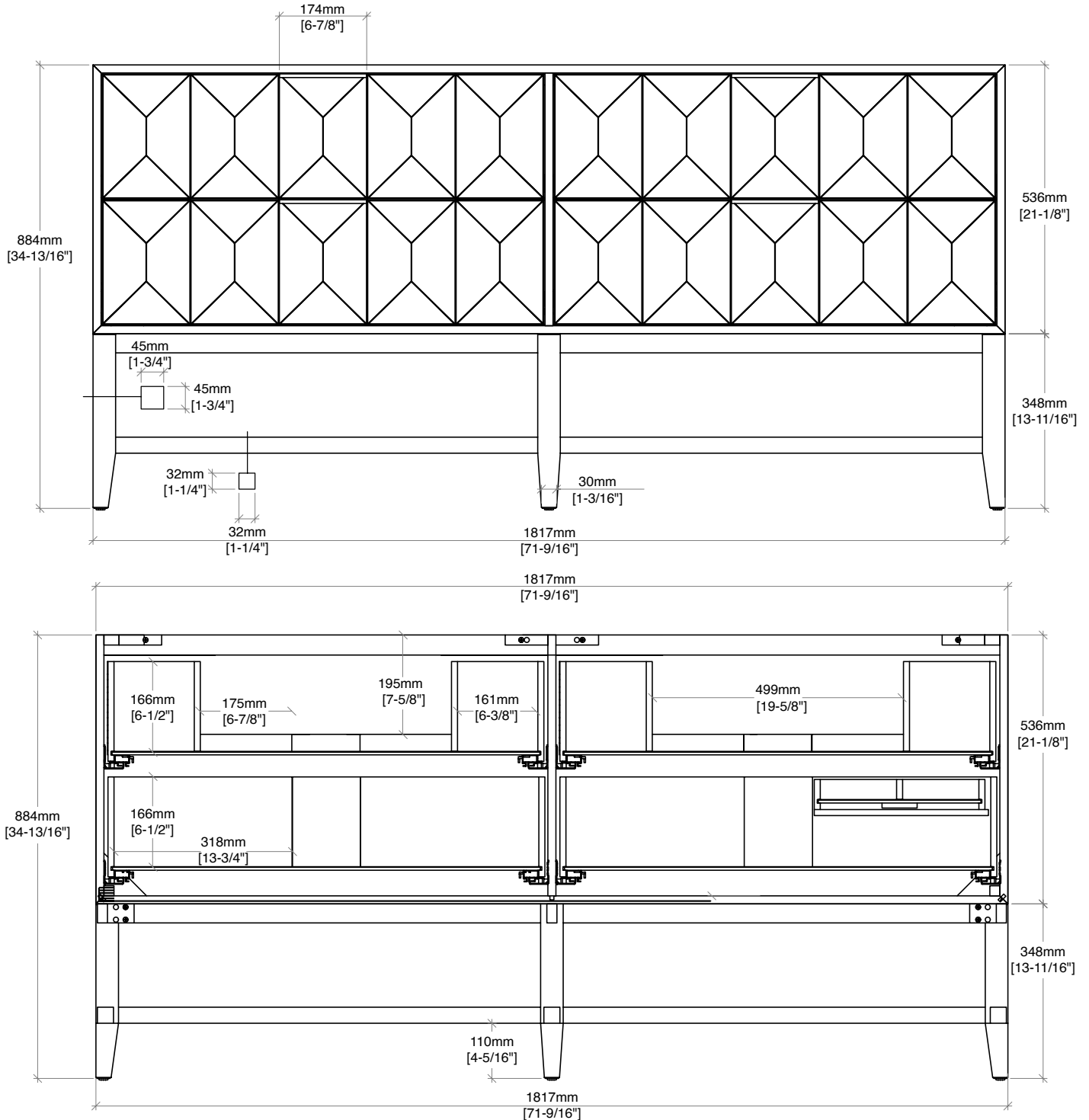

All dimensions and specifications are nominal and may vary. Use actual products for accuracy in critical situations. Diagrams are of cabinets only – James Martin Optional Countertops and sinks are not shown.

72" Emmeline Double Vanity

D100-V72-CSN

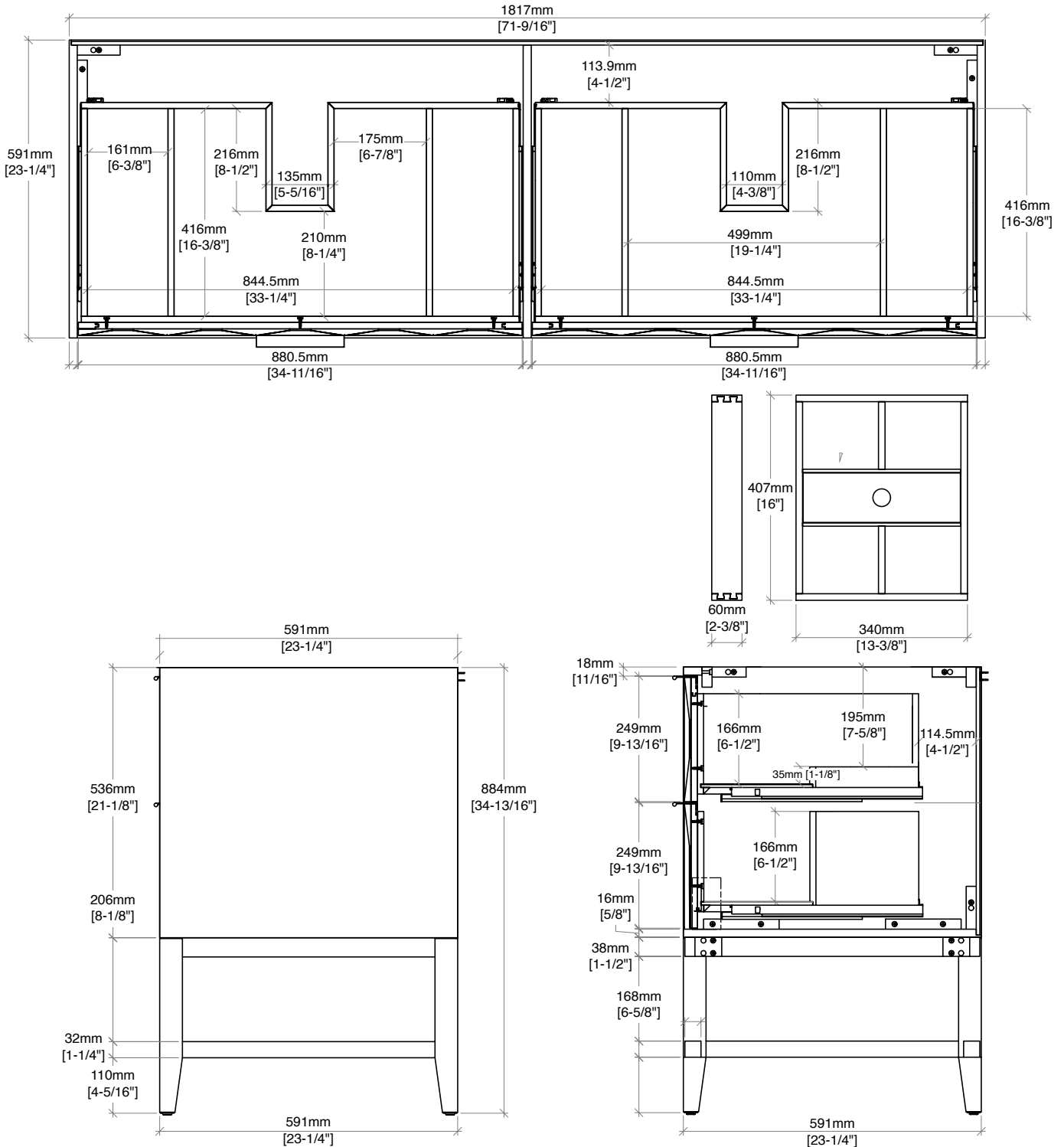

All dimensions and specifications are nominal and may vary. Use actual products for accuracy in critical situations. Diagrams are of cabinets only – James Martin Optional Countertops and sinks are not shown.

72" Emmeline Double Vanity

D100-V72-CSN

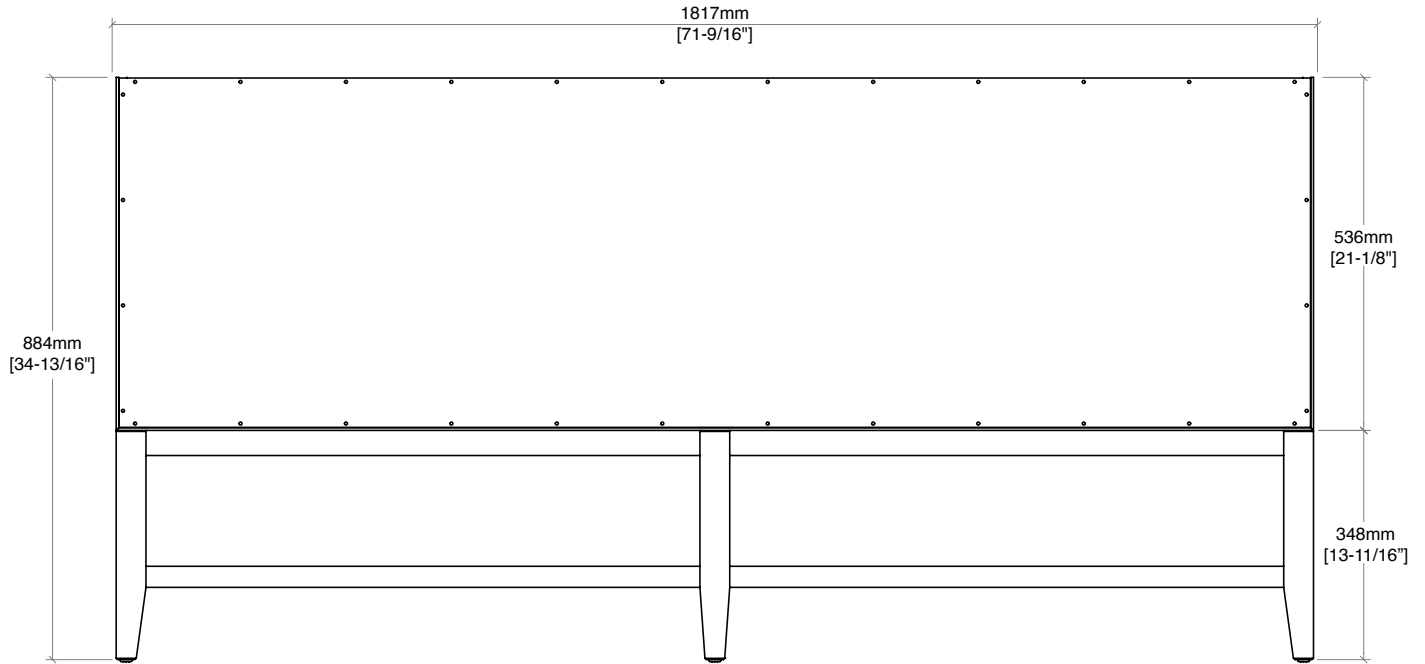

All dimensions and specifications are nominal and may vary. Use actual products for accuracy in critical situations.
Diagrams are of cabinets only – James Martin Optional Countertops and sinks are not shown.

Silestone Care and Maintenance

Silestone's hybrid composition consisting of premium minerals, quartz, and recycled materials makes it highly resistant to stains, preventing them from penetrating the surface and making daily cleaning easy and quick.

Routine Care: Simply wipe your Silestone surface with soap and water on a regular basis to maintain its beauty. For deeper cleaning, use any Ph-balanced (less than 10) general-purpose household cleaner. Q-Action cleaner is especially effective for the disinfection of kitchen countertops.

Using sealants and water repellants is not necessary to maintain the original sheen of your Silestone quartz top. Avoid using these products as they can create an undesirable build-up over time. If the surface of your Silestone countertop loses sheen, you may apply food-safe furniture spray.

Light Stains: Apply a small amount of a general-purpose household cleaner to the stain, let sit for 2 minutes and rub with a non-scratch scouring pad. Rinse immediately with water. For stains that harden as they dry, remove by gently scraping the surface with a razor blade or putty knife, holding it upright to avoid scratching the surface. Clean using warm, soapy water and rinse thoroughly.

Difficult/Stubborn Stains: The following products may be applied and let stand for 10 minutes before scrubbing and rinsing thoroughly. Caution should be exercised in the handling and storage of these chemicals.

Lacquer Thinner – Rubbing Alcohol – Ammonia – Mineral Spirits

Hardwater Stains: Apply a paste from equal parts baking soda and white vinegar. Let sit on the surface for 10-20 minutes and rub with a non-scratch pad. Rinse immediately with water.

General Precautions

Avoid using the following:

- Chlorine-based products
- Degreasing agents such as those used in oven cleaners
- Products high in alkaline (Ph over 10)

Heat Precautions

Although Silestone can withstand high temperatures for short periods of time, its performance varies with respect to different factors like thickness, color, location, etc. For this reason, it is not recommended that the product be exposed to sustained contact with a heat source, like curling irons, nor should hot saucepans, frying pans, deep-fat fryers, etc, be placed on it. The use of a hot pad or trivet is recommended in such situations.

Sun Exposure

- Silestone quartz is not intended for outdoor use
- Avoid places with UV lighting

Repairs

One of the most effective solutions for repairing scratches is to carefully fill them with grout or silica gel. Marble paste is also highly effective.

Because each type of damage needs to be carefully considered to determine the proper care method, we recommend consulting a professional.

26" 3cm COUNTERTOPS

SNK-RF

080-S26
090-S26
RECTANGULAR PORCELAIN
UNDERMOUNT SINK

JAMES MARTIN
VANITIES

080, 090 Series Tops

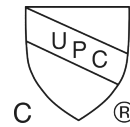
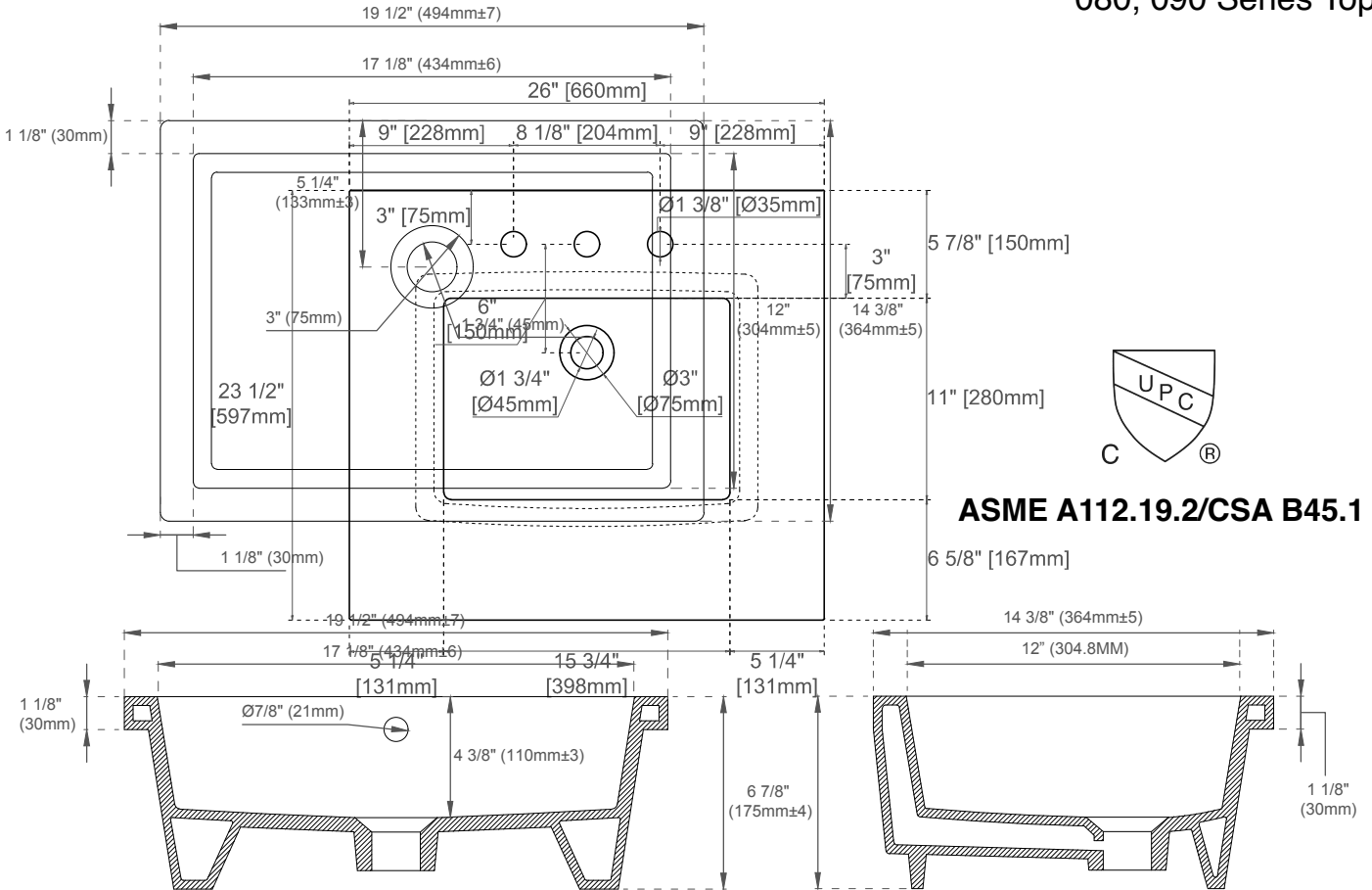

ASME A112.19.2/CSA B45.1

FEATURES:

- Designed to fit with all James Martin Vanities with a 3cm Silestone quartz top
- Sink Material: Porcelain
- Integrated overflow
- Sink shape: Rectangular with straight sides
- Sink ships in a separate carton from top and vanity
- Sink clips and hardware are not included. All mounting hardware ships with the 3cm quartz tops
- Drain included: NO
- Faucet included: NO
- Overflow cover: NO

EXTERNAL DIMENSIONS:

Length: 19-1/2"
 Width: 14-3/8"
 Height: 6-7/8"

INTERNAL BASIN DIMENSIONS:

Basin Length: 17-1/8"
 Basin Width: 12"
 Basin Depth: 4-3/8"
 Fits Drain Hole Size: 1-1/2"

All dimensions are nominal

Visit website for warranty and installation information
www.jamesmartinvanities.com

Version: 202301

Version:202301

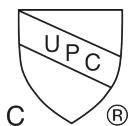

26" 3cm COUNTERTOPS

SNK-RF

080-S26
090-S26
**RECTANGULAR PORCELAIN
UNDERMOUNT SINK**

JAMES MARTIN
JAMES MARTIN
VANITIES

080, 090 Series Tops

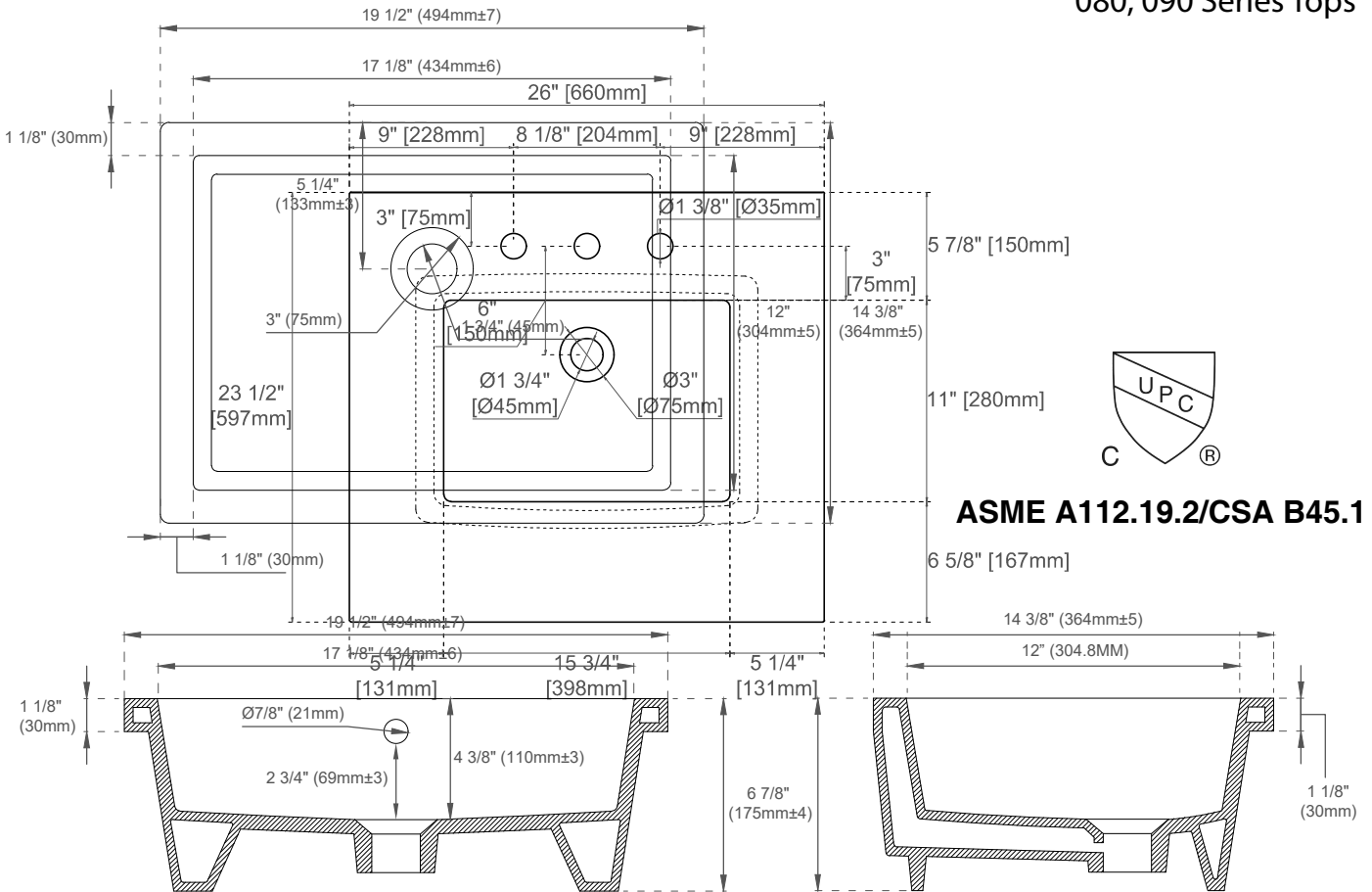

FEATURES:

- Designed to fit with all James Martin Vanities with a 3cm Silestone quartz top
- Sink Material: Porcelain
- Integrated overflow
- Sink shape: Rectangular with straight sides
- Sink ships in a separate carton from top and vanity
- Sink clips and hardware are not included. All mounting hardware ships with the 3cm quartz tops
- Drain included: NO
- Faucet included: NO
- Overflow cover: NO

EXTERNAL DIMENSIONS:

Length: 19-1/2"
 Width: 14-3/8"
 Height: 6-7/8"

INTERNAL BASIN DIMENSIONS:

Basin Length: 17-1/8"
 Basin Width: 12"
 Basin Depth: 4-3/8"
 Fits Drain Hole Size: 1-3/4"

All dimensions are nominal

Visit website for warranty and installation information
 Visit website for warranty and installation information
www.jamesmartinvanities.com
www.jamesmartinvanities.com

Version: 202301

Version:202301

