

60" S

Item Number:

650-V60S-BNM  
650-V60S-CWH  
650-V60S-UGR

JAMES MARTIN



VANITIES

Brittany 60" Cabinet

Diagrams with Dimensions  
page 01 of 03

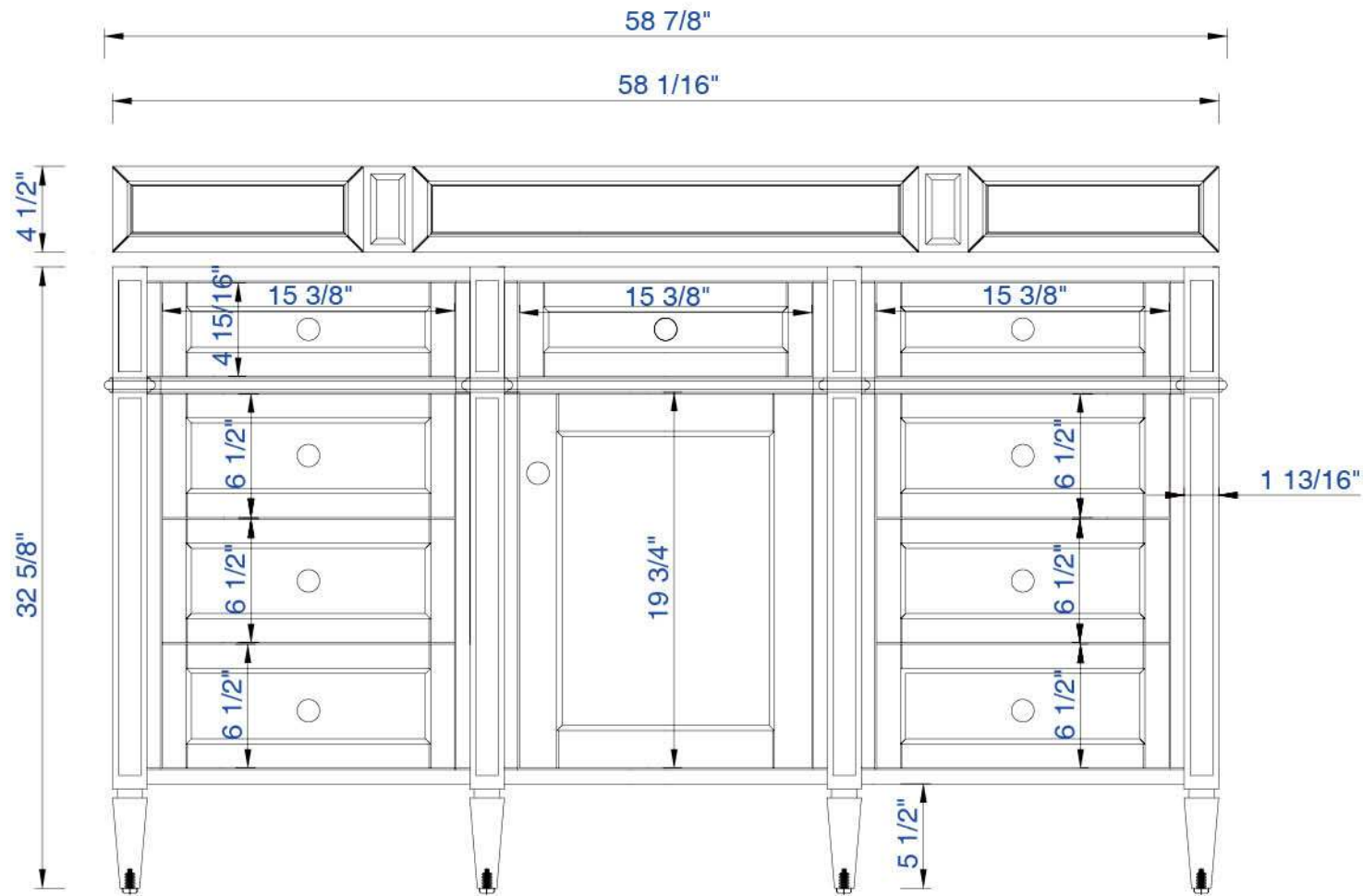

NOTE ONE: Countertops are not shown in these diagrams. (Cabinet Only)

NOTE TWO: Wood Backsplash (Shown) is designed for the molding detail to align with sinks in James Martin's Optional Countertops.

Customers' own countertops and sinks may align differently.

Please consult our website for Countertop Diagrams: [www.jamesmartinvanities.com](http://www.jamesmartinvanities.com)

60" S

Item Number:

650-V60S-BNM  
650-V60S-CWH  
650-V60S-UGR

JAMES MARTIN



VANITIES

Brittany 60" Cabinet

Diagrams with Dimensions  
page 02 of 03

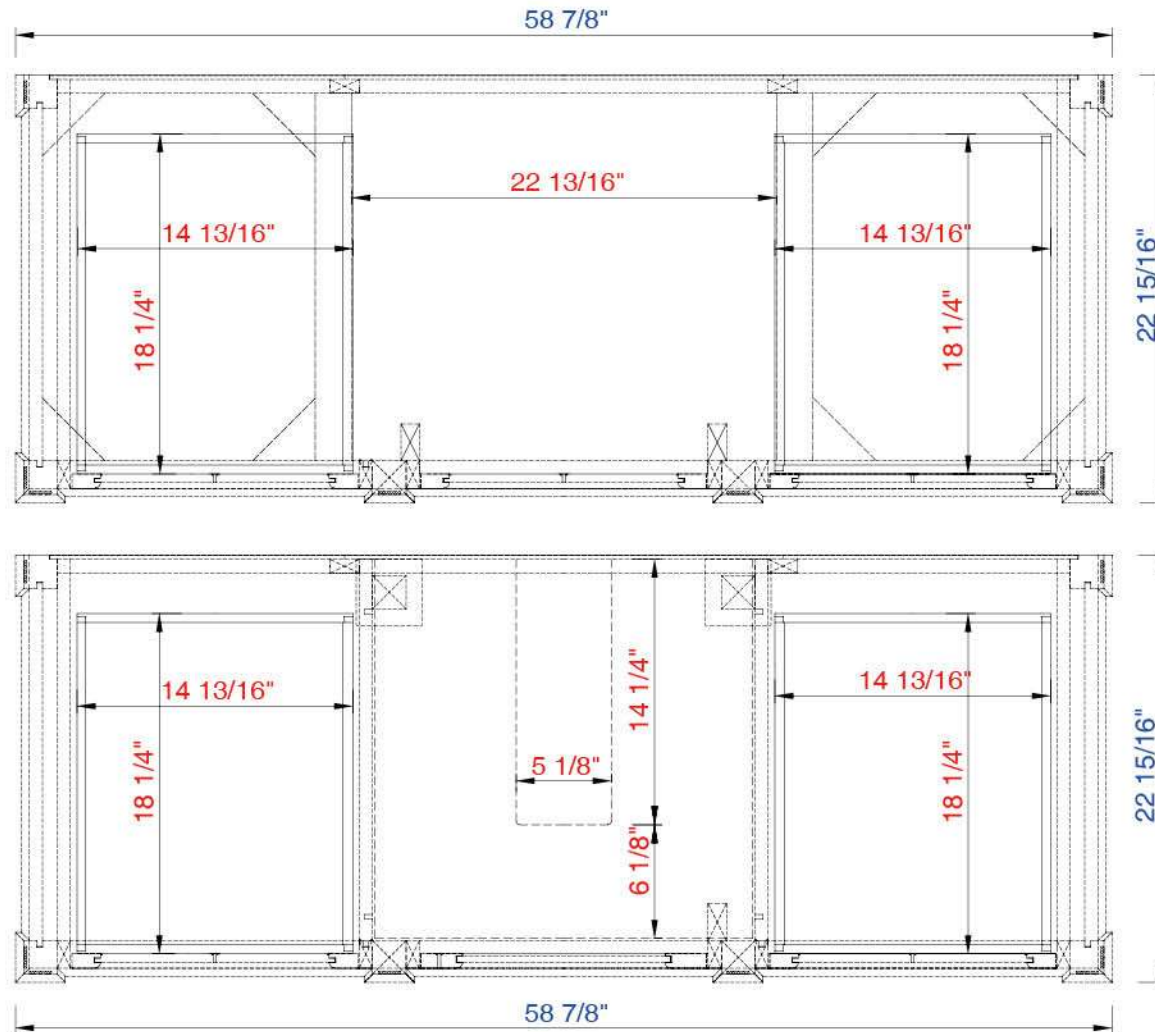

NOTE ONE: Countertops are not shown in these diagrams. (Cabinet Only)

NOTE TWO: Internal Shelves (Shown) are designed to align with sinks in James Martin's Optional Countertops.

Customers' own countertops and sinks may align differently, and modification may be required.

Please consult our website for Countertop Diagrams: [www.jamesmartinvanities.com](http://www.jamesmartinvanities.com)

60" S

Item Number:

650-V60S-BNM  
650-V60S-CWH  
650-V60S-UGR

JAMES MARTIN



VANITIES

Brittany 60" Cabinet

Diagrams with Dimensions  
page 03 of 03

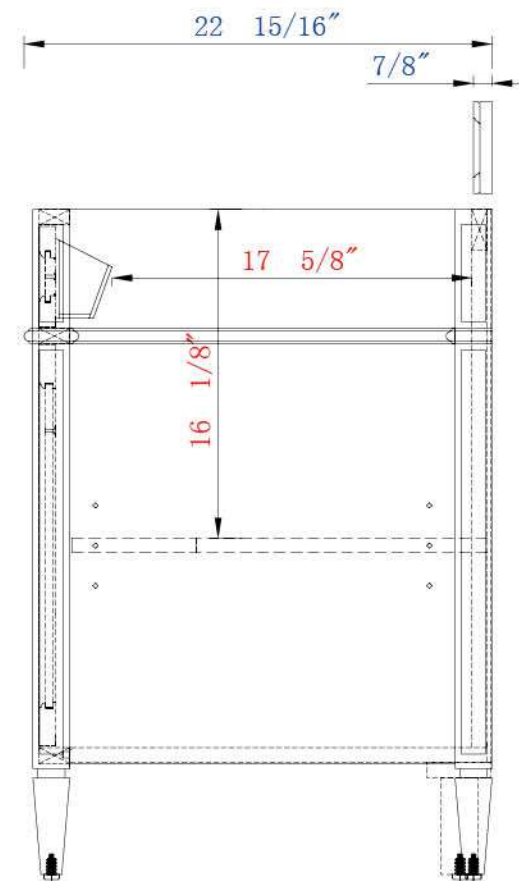
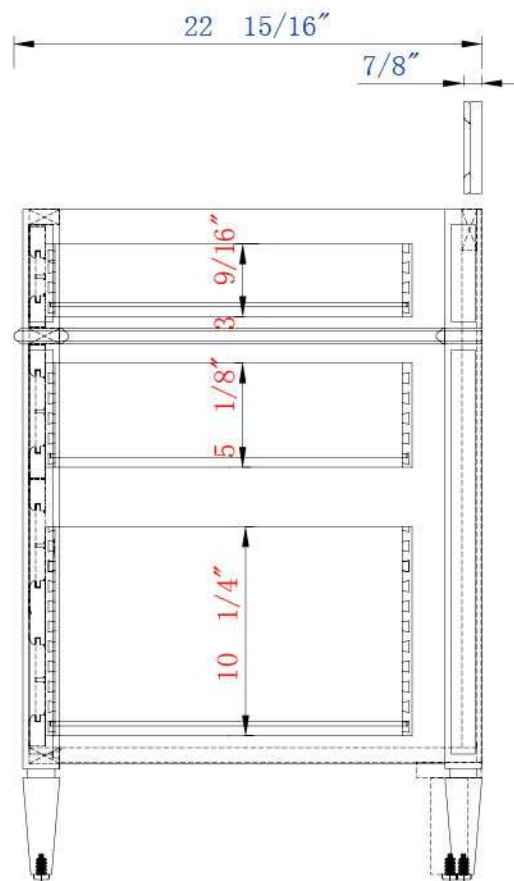
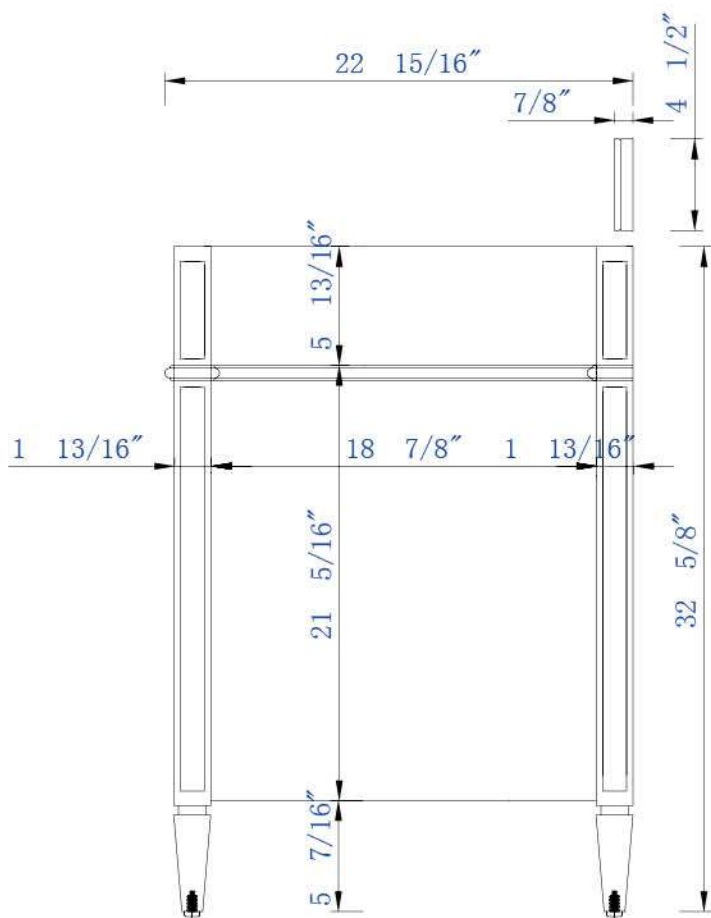

NOTE ONE: Countertops are not shown in these diagrams. (Cabinet Only)

NOTE TWO: Wood Backsplash (Shown) is designed for the molding detail to align with sinks in James Martin's Optional Countertops.

Customers' own countertops and sinks may align differently.

Please consult our website for Countertop Diagrams: [www.jamesmartinvanities.com](http://www.jamesmartinvanities.com)

1524mm

Item Number:

650-V60S-BNM  
650-V60S-CWH  
650-V60S-UGR

JAMES MARTIN



VANITIES

Brittany 1524mm Cabinet

Diagrams with Dimensions  
page 01 of 03

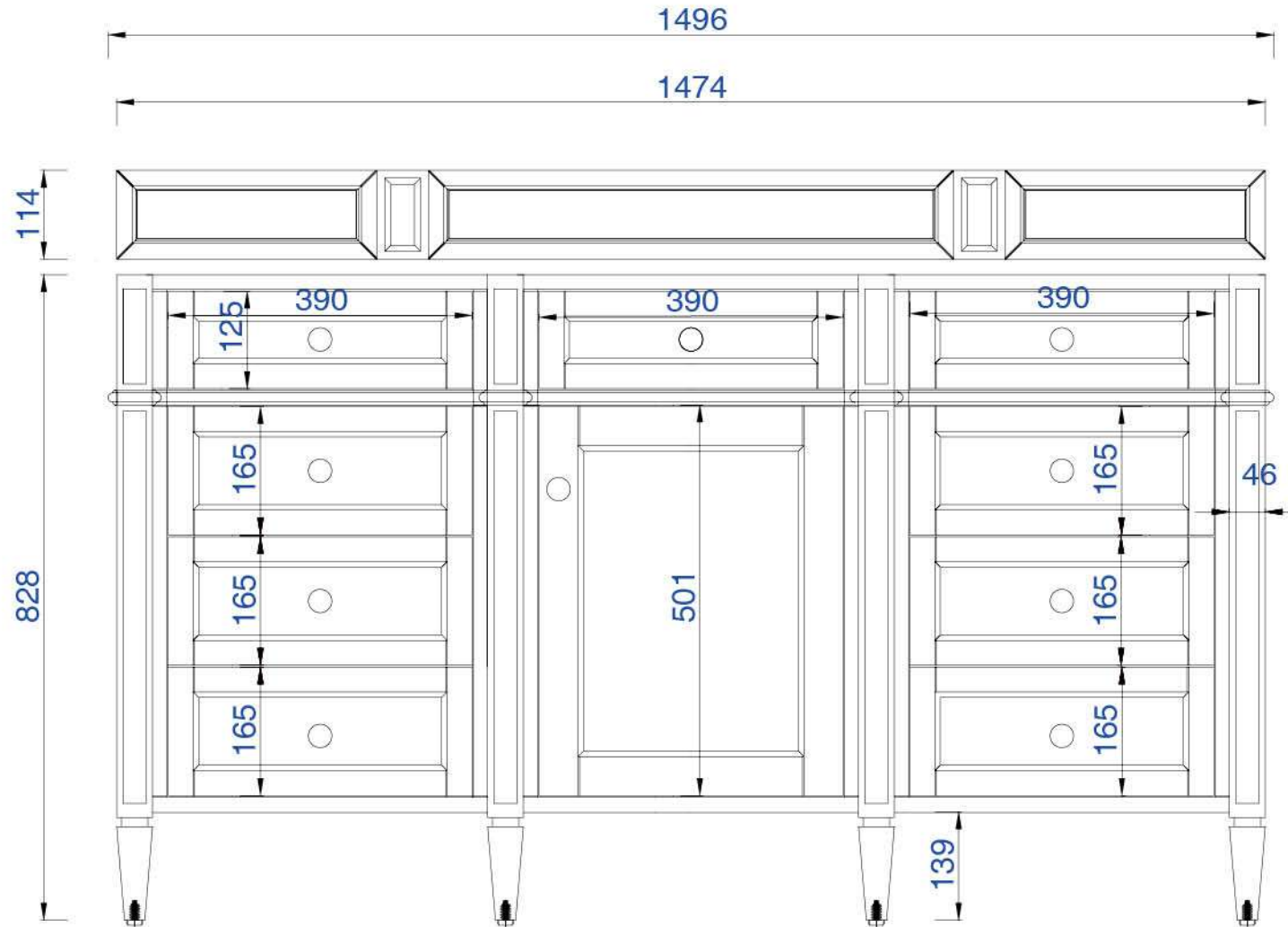

NOTE ONE: Countertops are not shown in these diagrams. (Cabinet Only)

NOTE TWO: Wood Backsplash (Shown) is designed for the molding detail to align with sinks in James Martin's Optional Countertops.

Customers' own countertops and sinks may align differently.

Please consult our website for Countertop Diagrams: [www.jamesmartinvanities.com](http://www.jamesmartinvanities.com)

1524mm

Item Number:

650-V60S-BNM  
650-V60S-CWH  
650-V60S-UGR

JAMES MARTIN



VANITIES

Brittany 1524mm Cabinet

Diagrams with Dimensions  
page 02 of 03

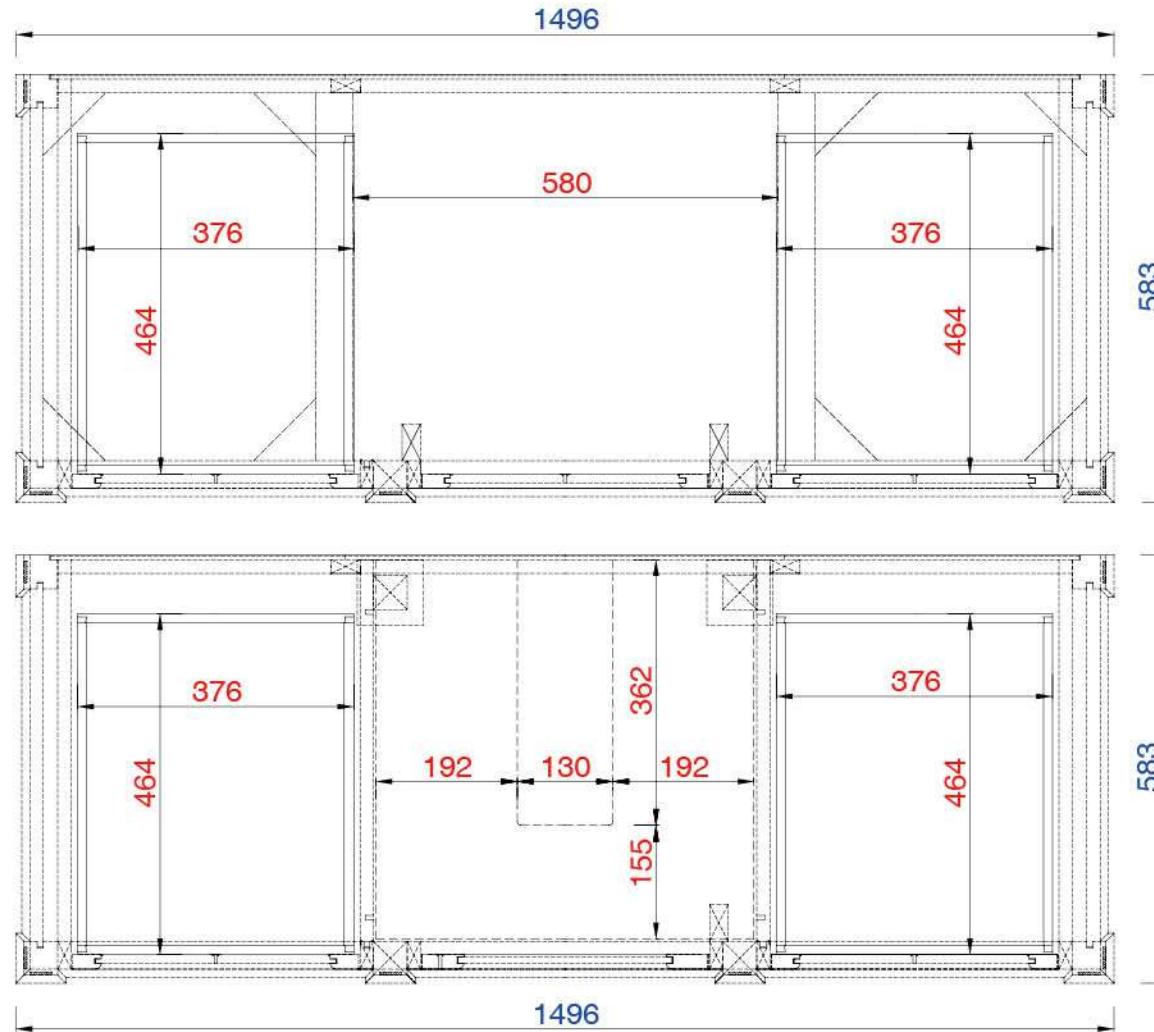

NOTE ONE: Countertops are not shown in these diagrams. (Cabinet Only)

NOTE TWO: Internal Shelves (Shown) are designed to align with sinks in James Martin's Optional Countertops.

Customers' own countertops and sinks may align differently, and modification may be required.

Please consult our website for Countertop Diagrams: [www.jamesmartinvanities.com](http://www.jamesmartinvanities.com)

1524mm

Item Number:

650-V60S-BNM  
650-V60S-CWH  
650-V60S-UGR

JAMES MARTIN



VANITIES

Brittany 1524mm Cabinet

Diagrams with Dimensions  
page 03 of 03

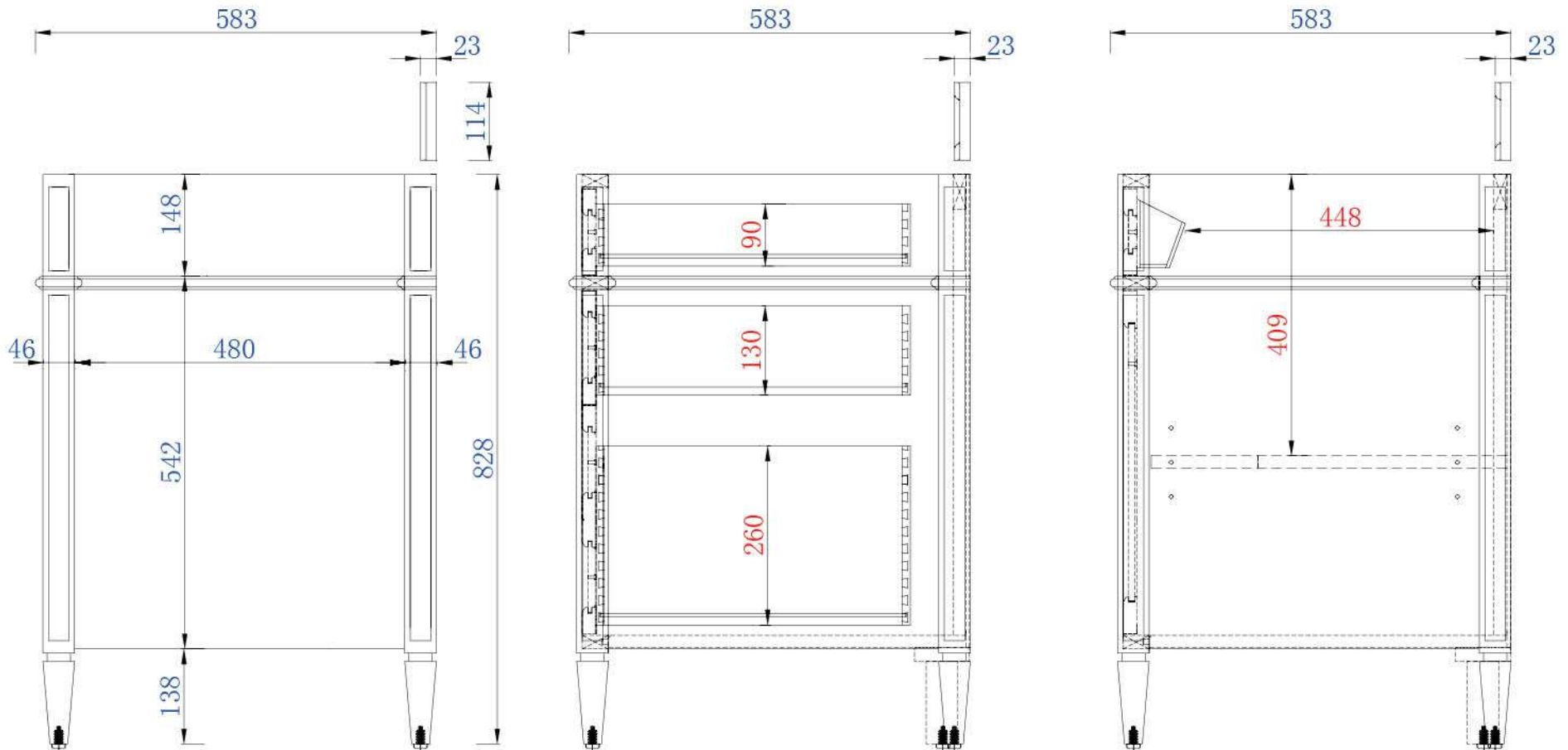

NOTE ONE: Countertops are not shown in these diagrams. (Cabinet Only)

NOTE TWO: Wood Backsplash (Shown) is designed for the molding detail to align with sinks in James Martin's Optional Countertops.

Customers' own countertops and sinks may align differently.

Please consult our website for Countertop Diagrams: [www.jamesmartinvanities.com](http://www.jamesmartinvanities.com)