

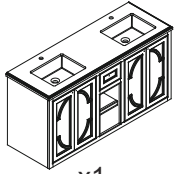

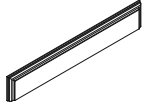



Model: Odyssey - 60"

Installation Instructions

Notes: We recommend that you rough-in the drain and water lines after receiving the unit.
 The vanity should be installed by a professional plumber.
 Drainer pipe and trap are not included.
 If you experience any difficulties with this product, do not return to the point of purchase. Please contact LAVIVA directly at support@lavivaforlife.com, and we will help resolve your issue.

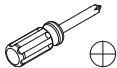
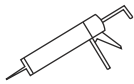
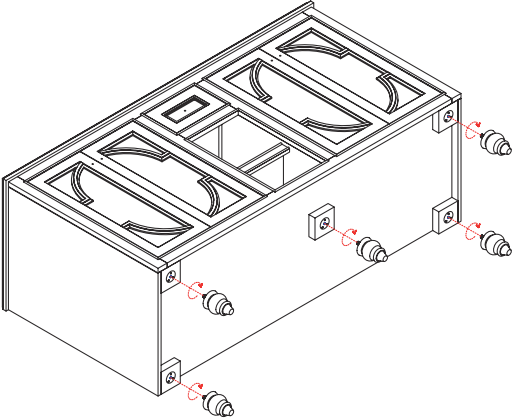
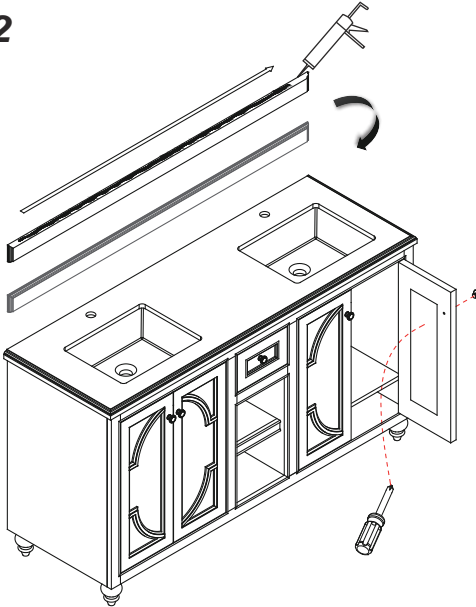
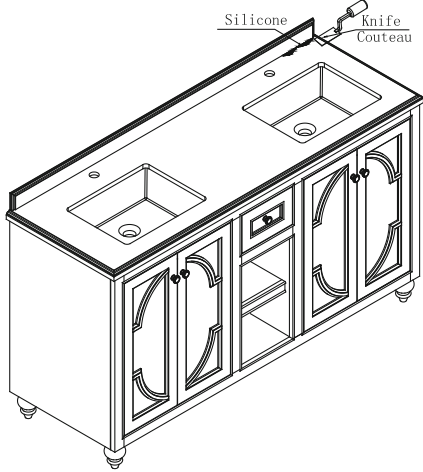
	A (cabinet)	B (backsplash)	C (screw)	D (handle)	E (foot)
Part List	 x1	 x1	 x5	 x5	 x5
Tools required	 screwdriver(phillips)	 silicone	 level	 tape measure	
Step 1					
Step 2					
Step 3					
Step 4	