

HOSPITALITY SERIES

Bar Sink Model 1515-6BS



1515-6BS

FEATURES

- Premium grade T-304 stainless steel
- 6" depth • 2 holes
- 24 gauge
- Super-Silencer pad
- Lustrous satin with highlighted rim
- Fits 18" sink base
- 2" drain opening
- Supplied with fasteners and instructions
- Complies with ASME A112.19.3-2000, UPC®
- Lifetime Limited Warranty



OPTIONAL ACCESSORIES

Bottom Grid: BG-1300

Strainer: 190-4200

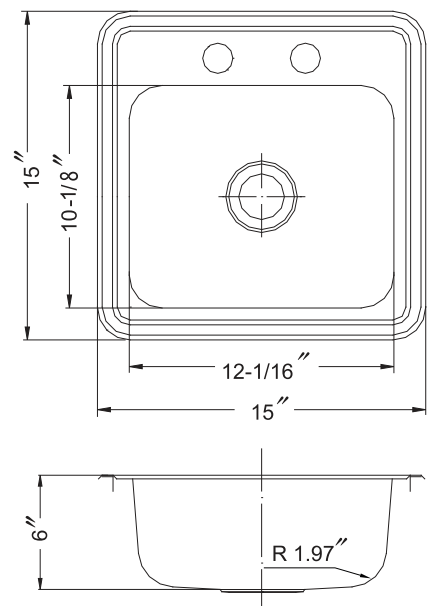

Installation profile

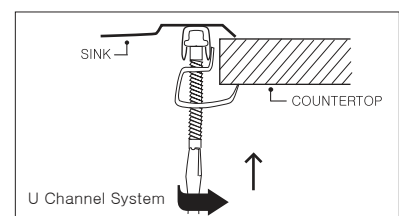
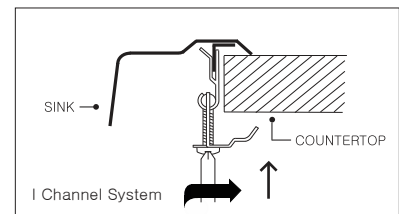

OVERALL DIMENSIONS	EACH BOWL	CUTOUT SIZE	PACKAGING*	WEIGHT*
15" x 15"	12-1/16" x 10-1/8"	14-1/4" x 14-1/4"	1/48/40 pcs.	6/270/180 lbs.

*Standard packaging: Single boxed /Pallet of single boxed/Pallet of bulk pack.
All dimensions are in inches. Specifications subject to change without notice.

Project/Job name _____

Architect/Engineer _____

Contractor _____

Model _____ Q'ty _____

Notes _____