

WYNDHAM COLLECTION

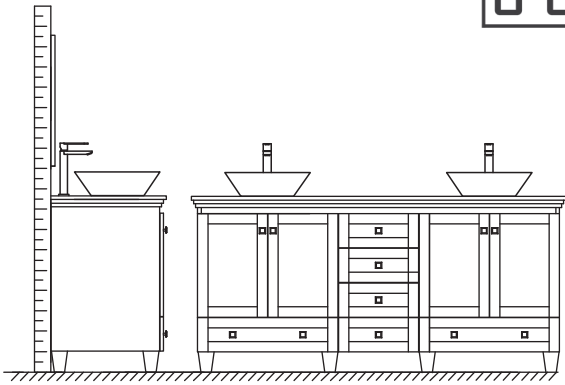

- Prior to installation, please check received items against the "Packing List".
- Please report any missing items to your retailer immediately
- Protect all surfaces from sharp objects, high heat sources, direct prolonged sunlight and chemical hazards.
- Professional installation recommended.

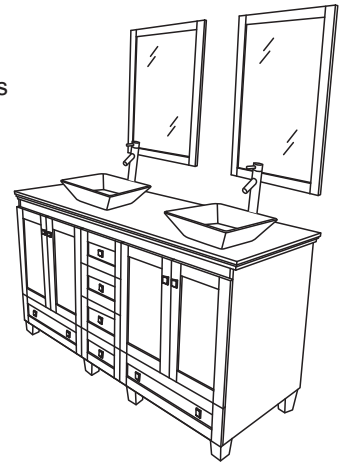

PACKING LIST

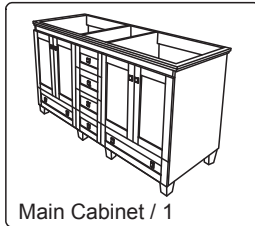

Main Cabinet / 1

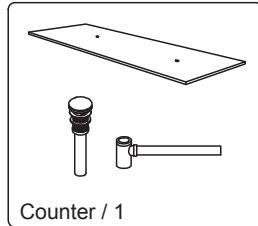

Counter / 1

OPTIONAL

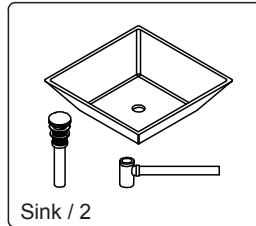

Sink / 2

OPTIONAL

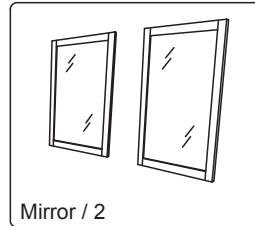

Mirror / 2

OPTIONAL

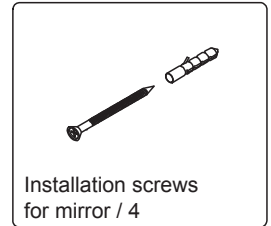

Installation screws
for mirror / 4

INSTALLATION AND ADJUSTMENT OF HINGES

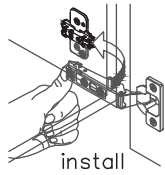

install

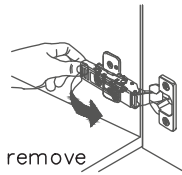

remove

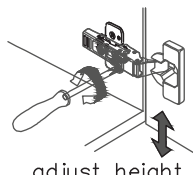

adjust height

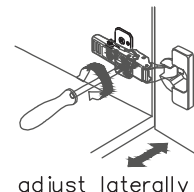

adjust laterally

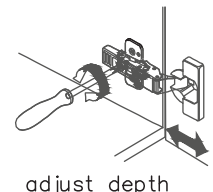

adjust depth

REQUIRED TOOLS NOT IN BOX

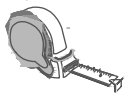

Tape measure



Pencil



Electric Drill

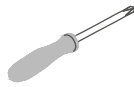

Phillips Screwdriver



Adjustable Wrench



Spirit Level



Silicone sealant

WC-CG8000-72
OVERMOUNT INSTALLATION

WYNDHAM COLLECTION

INSTALLATION INSTRUCTIONS

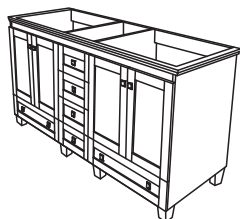

Cut hole in
back of cabinet

① Installer must cut appropriately sized hole in back of cabinet to accommodate existing placement of hot&cold wall valves and drains

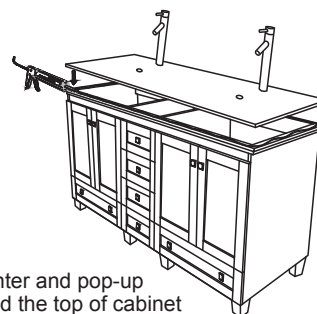

② Install the counter and pop-up drain. Seal around the top of cabinet with clear or white silicone sealant.

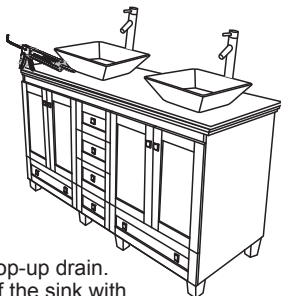

③ Install the sink and pop-up drain. Seal around the base of the sink with clear or white silicone sealant.

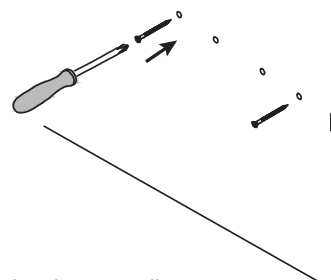

④ Attach mirror brackets to wall with supplied screws. Hang mirrors.

WC-CG8000-72
OVERMOUNT INSTALLATION