



EXCLUSIVE
HERITAGE

INSTALLATION GUIDE
FOR ALL UNDERMOUNT SINKS



INSTALLATION INSTRUCTIONS



ATTENTION INSTALLER

Please carefully read our installation guide prior to installation. Make sure you have observed your local plumbing and building codes thoroughly before you begin.

- Metal edges may be sharp, please use caution when handling. You should always wear gloves.
- Carefully unpack your new sink and make sure all necessary parts are included (sink, mounting brackets and cutting template). If any items are missing, contact us within 5 days of delivery.
- Inspect your sink for any signs of damage prior to installation. Please do not install a damaged sink.
- Installation of the sink must be completed by a professional licensed plumber.
- The warranty will be voided if the installation instructions are not followed.
- Requirements vary for installation in granite, quartz, marble, laminate, stone or butcher block tops.
- Template is provided only for reference, carefully measure the actual sink for an accurate cut out.
- Please discuss the desired finished appearance with your customer prior to installation.
- Exclusive Heritage undermount sinks should only be installed onto a solid surface countertop.
- Exclusive Heritage is not responsible for damage to the sink, countertop, plumbing or any other fixtures caused by improper installation.
- Appropriate clearances must be accounted for to accommodate backsplashes, faucets and plumbing.
- Any excess silicone adhesive around the sink must be removed and cleaned immediately.
- Always wear proper safety gear to protect yourself from injury.

CUSTOMER SUPPORT

For questions and comments, please contact us at support@ehhomeusa.com.

To learn more about Exclusive Heritage or our product line, you can visit our website at <http://www.exclusiveheritageusa.com>.

NOTE: This installation manual is specifically written for both single and double undermount sinks.

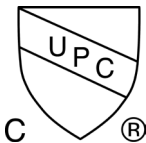

RECOMMENDED TOOLS AND MATERIALS NEEDED

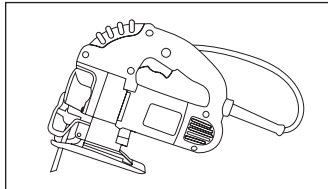

Jig Saw

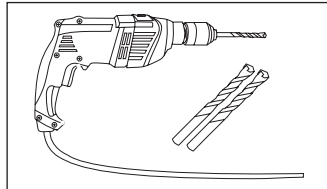

Drill & Drill Bits

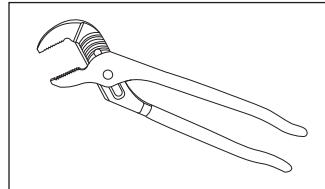

Channel Locks

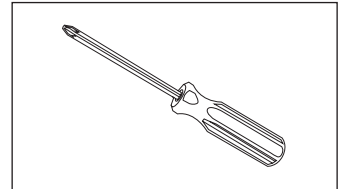

Phillips Screwdriver

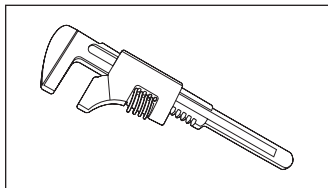

Adjustable Wrench

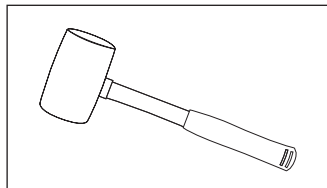

Rubber Mallet

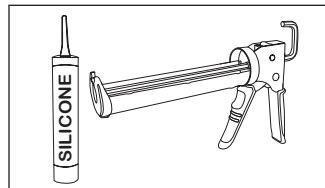

Caulk and Caulk Gun

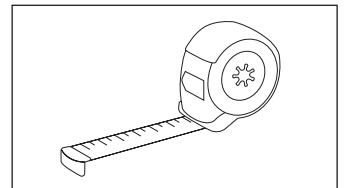

Tape Measure

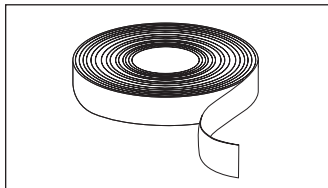

Tape

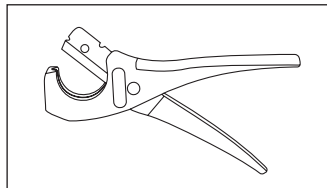

Tubing Cutter

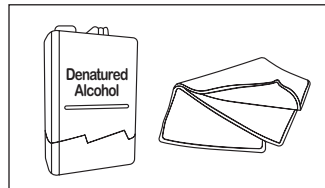

Denatured Alcohol

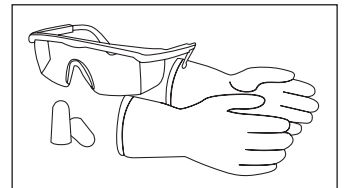

Protective Gear



Please always wear personal safety devices for your protection and use proper tools for installation

MOUNTING OPTIONS

POSITIVE REVEAL

The rim of the sink is exposed beyond the countertop edge.

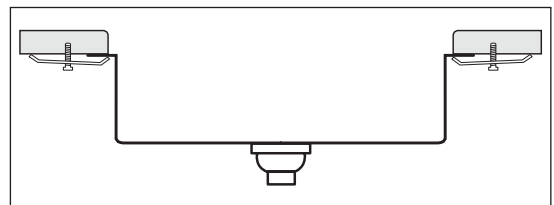

NEGATIVE REVEAL

The countertop edge extends over the rim of the sink.

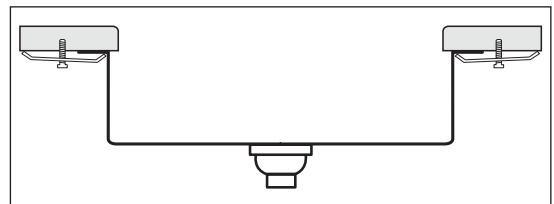

ZERO/FLUSH REVEAL

The sink will align flush with the countertop edge.

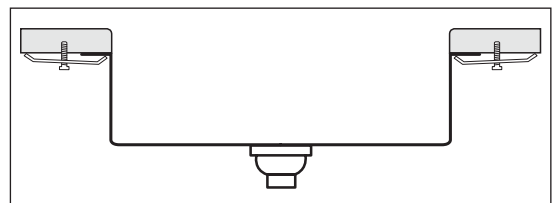

UNDERMOUNT SINK APPLICATION

STEP 1 - POSITION OF THE SINK

- Determine where the sink will be positioned on the countertop.
- Make sure there is sufficient clearance of the sink on all sides below the countertop.
- Carefully tape the cutting template to the countertop at the appropriate position (Templates are provided only for reference, carefully measure the actual sink dimensions).
(Figure 1)

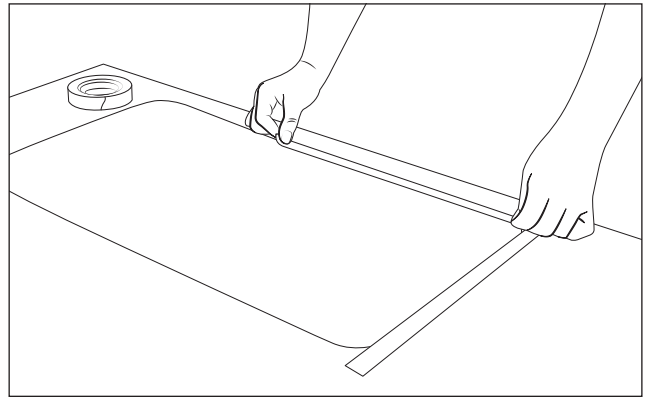

Figure 1

STEP 2 - CHOOSE MOUNTING OPTION

- Determine which reveal you want your sink to have: Positive Reveal, Negative Reveal or Zero/Flush Reveal (See Mounting Options for details).
- If you want a Negative Reveal, cut the hole smaller than the template. For a Positive Reveal, cut the hole slightly larger. For a Zero/Flush Reveal, cut to the exact measurements of the template.

(Figure 2)

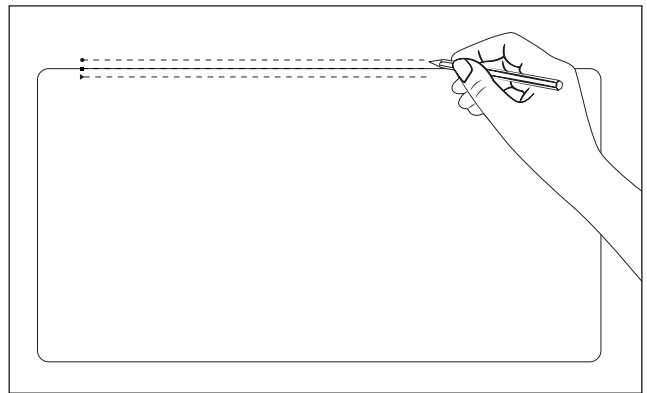

Figure 2

STEP 3 - CUTTING THE COUNTERTOP

- Choose the appropriate saw for the type of countertop material being used.
- Carefully follow the predetermined reveal cutting outline to create the proper opening for the sink.
- Always wear proper safety gear to protect yourself from injury.

(Figure 3)

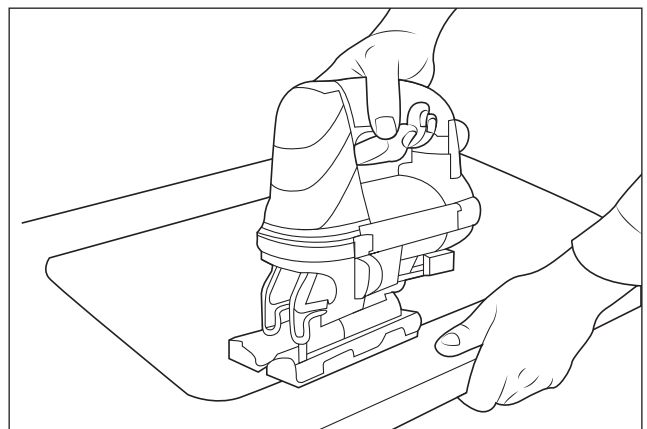

Figure 3

UNDERMOUNT SINK APPLICATION

STEP 4 - DRILL HOLES ON THE COUNTERTOP

- Review the clip length carefully where the edge of the clips should overlap the sink rim.
- Use 3 clips on the long sides of the sink. Use 2 clips on the short sides of the sink. The holes should be evenly spaced apart from each other starting near the corner.
- Determine the thickness of the countertop. Use a drill bit with a stop block to avoid drilling through the countertop.
- Always wear proper safety gear to protect yourself from injury.
- Drill holes on the underside of the countertop. All holes must be smaller than the screw size. (Figure 4)

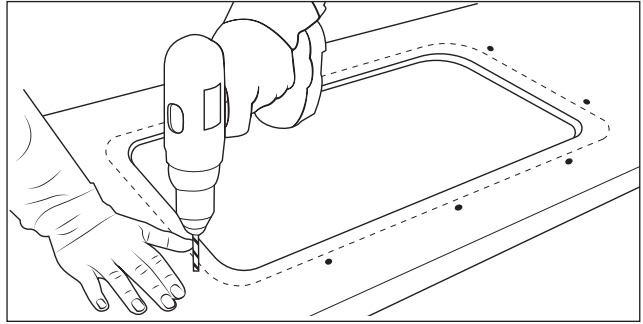

Figure 4

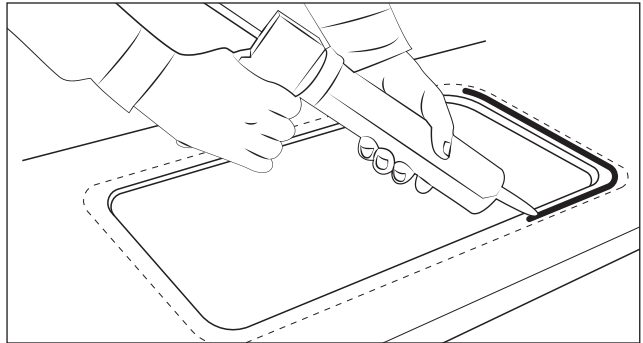

Figure 5.1

STEP 5 - APPLY SILICONE ADHESIVE

- With the countertop upside down, use denatured alcohol to thoroughly clean the countertop holes and sink rim prior to attaching the sink.
- Apply a bead of silicone adhesive along the edge of the hole in the countertop.
- Place sink on the countertop. (Figure 5.1, Figure 5.2)

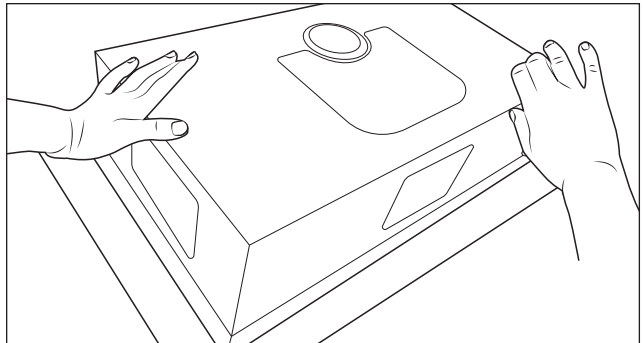

Figure 5.2

STEP 6 - ATTACH SINK ON THE COUNTERTOP

- It is recommended to install a faucet before installing the sink.
- Please be aware that solid surface countertop hardware may vary based on the material of the countertop.
- Insert the anchors into drilled holes and gently tap with a rubber mallet until flush
- Attach the mounting hardware to secure the sink on the countertop. (Figure 6.1, Figure 6.2)

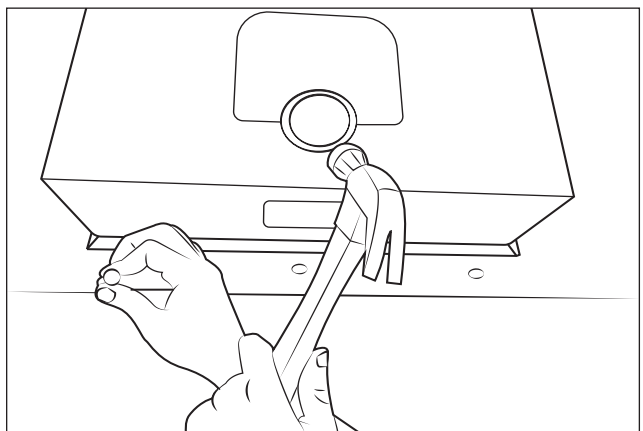

Figure 6.1

UNDERMOUNT SINK APPLICATION

STEP 7 - CLEANING UP

- Use a soft cloth with denatured alcohol to wipe off any excess silicone adhesive from the inside lip of the bowl after the sink is attached to the countertop. Always follow the cleaning directions on the label of the silicon adhesive.
(Figure 7)

STEP 8 - CHECK FOR LEAKS

- Run a small amount of water into the sink and check for leaks under the cabinet.
- Make proper adjustments or repairs if leaks are found.
(Figure 8)

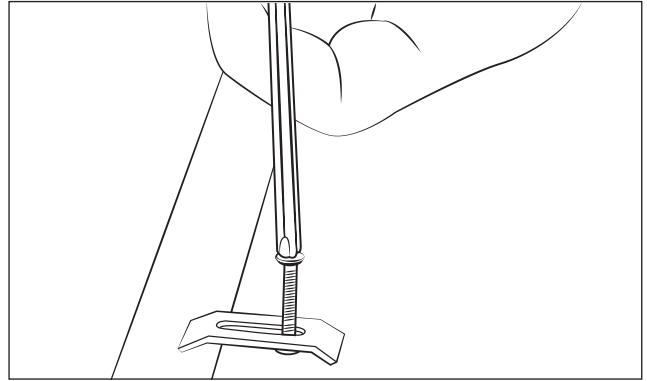

Figure 6.2

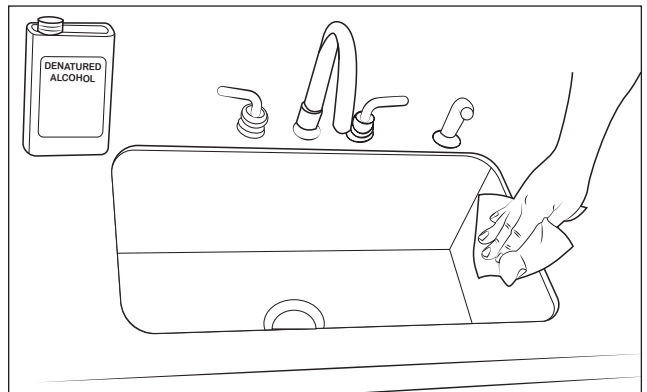

Figure 7

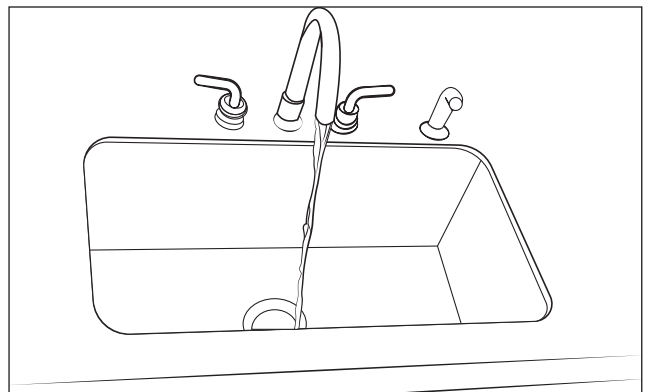

Figure 8

STAINLESS STEEL STRAINER

1 OPEN / CLOSE STOPPER

2 STRAINER BASKET

3 STRAINER BODY

4 RUBBER GASKET

5 PAPER WASHER

6 LOCKNUT

T304

PREMIUM
STAINLESS
STEEL

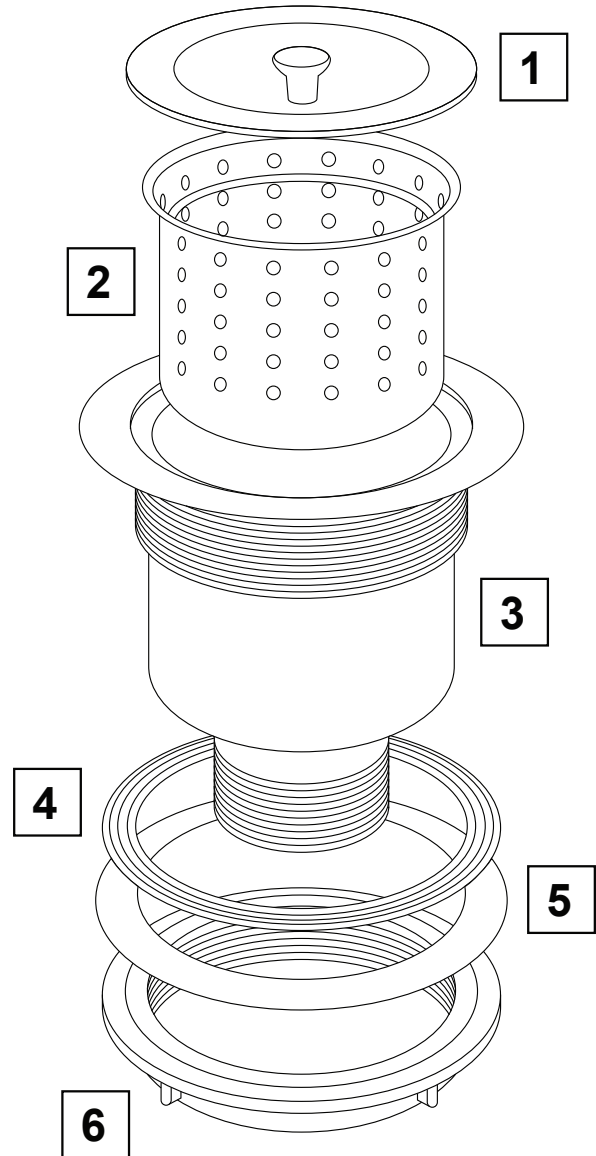

NOTE:

- Installation of the strainer must be completed by a professional licensed plumber.
- Always wear proper safety gear to protect yourself from injury.

For questions and comments, please contact us at support@ehhomeusa.com. To learn more about Exclusive Heritage or our product line, you can visit our website at <http://www.exclusiveheritageusa.com>.

OUR STORY

The late 1930's and early 1940's were a period of turmoil and uncertainty. Many of the lifelong dreams of hard working men and women came crashing down as World War II took its toll.

My grandfather was one of many men who took pride in what he could create with his bare hands, his vision and his imagination. As an accomplished carpenter for most of his life, he knew the characteristics of great furniture making. He appreciated detail, fine tools, intricate inlays and master craftsmanship.

He spent decades carefully crafting piece after piece for sale in a popular furniture store. He saved his money in hopes of one day creating his own furniture line. Like many businesses of his time, he was never able to fulfill his dreams due to the economic and business hardships faced by many families.

Each family had a different hardship story to tell. My grandfather remembers the day a bomb went off in his building and he witnessed the destruction of many buildings in the city where he lived. There was no food for days and many families suffered.

While his dream never materialized, his vision and timeless secrets have been passed down to a new generation dedicated to seeing his dream come true. Exclusive Heritage is the 'must have' collection of artistic brilliance and restored elegance. It includes a wide selection of furniture and each piece has a story to tell and a life all its own.

When you invest in furniture and accessories through Exclusive Heritage, you are among the discriminating buyers across the globe who choose shapely pieces, fine detailed lines and unique stylings over mass production and common materials.

PASSION AND MISSION

A new generation has vowed to honor the vision and dreams of their loved ones by bringing their treasured family secrets alive again. They embraced their motivation for design by creating classic and modern fused pieces that can become part of your family history and traditions. They understand that master craftsmanship is an art as much as a science. It comes from the beauty of one man's eyes and his vision for something greater than to fill up the space in a corner. It is a conversation piece and keepsake all at the same time.

It is a great honor to carry out the mission and vision of my grandfather as well as the dreams of many men from that era in time. As we bring closure to their dreams, we also create new ones for our own generation and those that follow.





OUR PRODUCTS

There are so many interesting ways to bring together today's tools with our traditional craftsmanship skills. Imagine how inspiring the creations must be.

We value quality, history and elegance to bring you today's diverse product lines. Although each piece is unique, it carries the tradition of the noble pursuit of my grandfather and others of his same generation. When you see our new furniture and fixture line, you are instantly reminded of a time where the primary motivation in creation was to take your breath away with designs, carvings and details of timeless elegance and beauty.

Our unique home improvement products are perfectly suited for those who have an appreciation for well built traditional furniture and fixtures of past generations, yet updated and exquisitely designed to fit into today's modern built homes.

GIVING BACK

While we are passionate about customized furniture and home furnishing creations, we are also committed to extend a helping hand to those in need.

We have sponsored with the No Kid Hungry program where meals are hand delivered to hungry kids. With 1 in 5 kids in America suffering from hunger, it is a great privilege to support this organization which does so much for kids in need. It is a great way to honor my grandfather's memory by giving back to a cause close to our hearts.

By supporting this cause, we hope to change the cycle of poverty that perpetuates when the basic needs of kids are not being met. We are committed to delivering 2,400 meals in our first year to this exceptional program and will increase our contribution as our company grows.

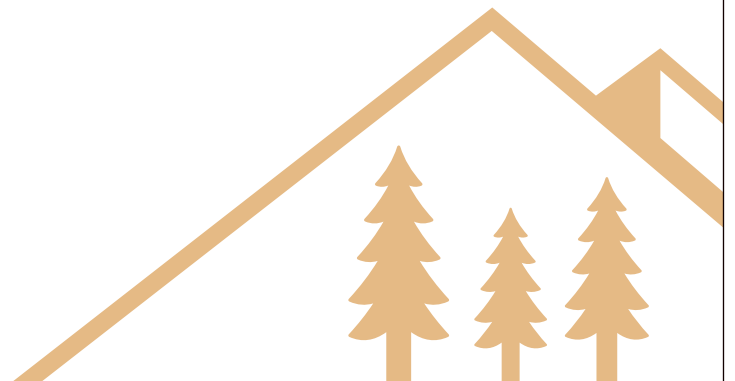



EXCLUSIVE
HERITAGE