

SKU : ES30036
SIZE:914x560x910
PROHIBIT COPY

. Prior to installation please check received items against the Packing List Please report any missing items to your local dealer immediately.
 . Protect all surfaces from sharp objects, high heat sources, direct prolonged sunlight and chemical hazards.
 . Professional installation recommended.

PACKING LIST

1. Main cabinet

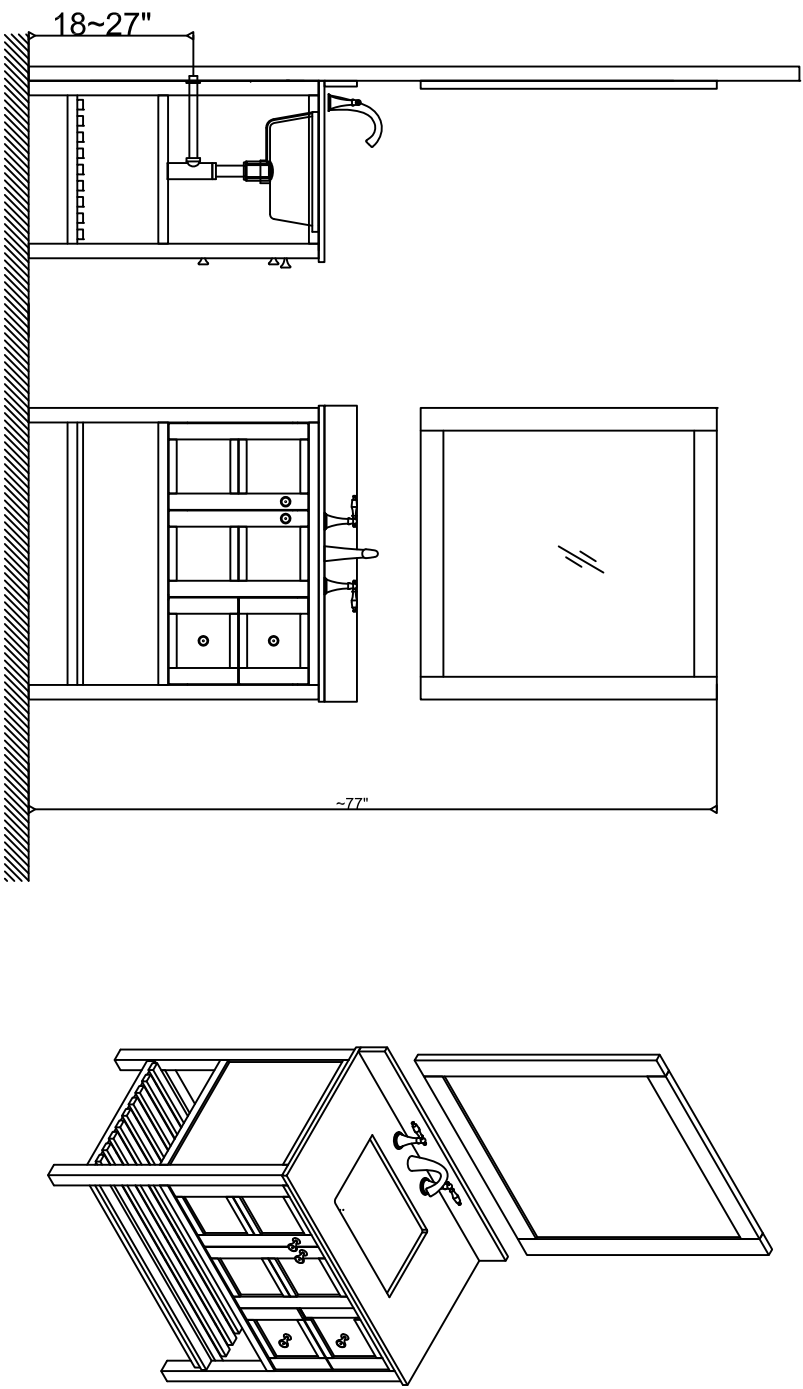
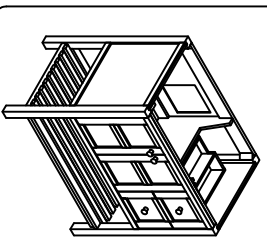

2. Mirror

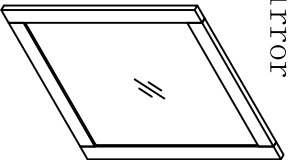

3. Basin

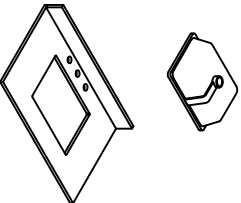

4. Pop up+Drain pipe

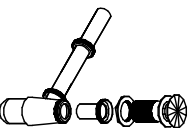

5. Faucet



6. Install screw

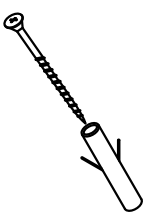

SKU : ES30036

SIZE:914x560x910

PROHIBIT COPY

REQUIRED TOOLS

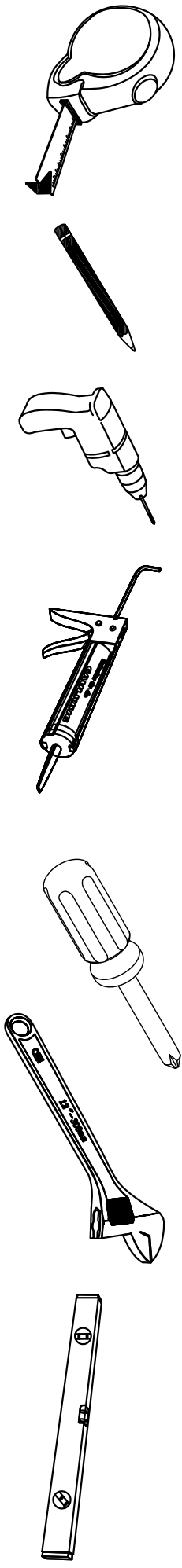

DRAWER SLIDER ATTACHMENT AND DETACHMENT

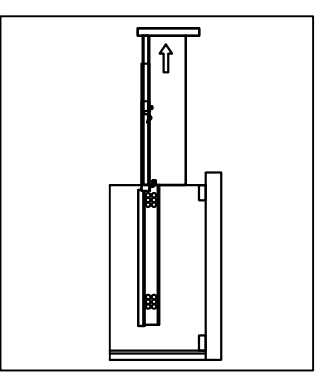
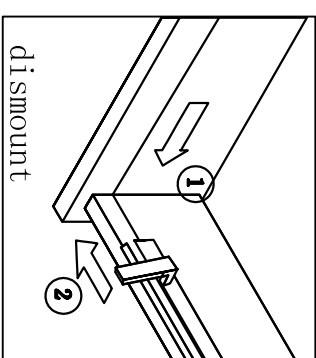
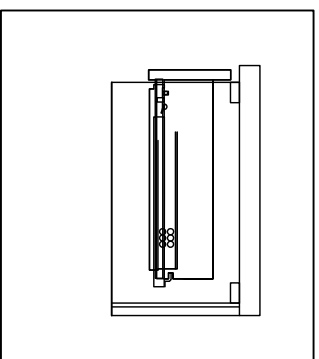
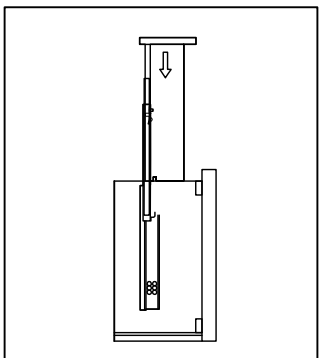
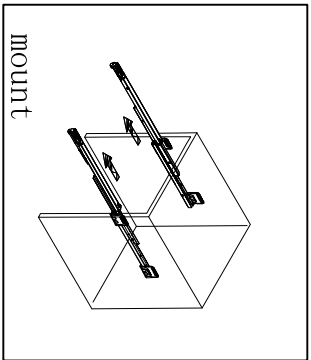

INSTALLATION AND ADJUSTION OF HINGE

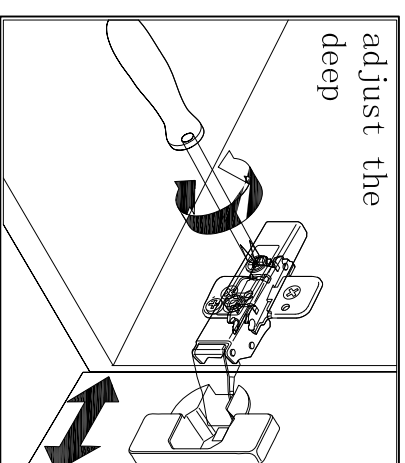
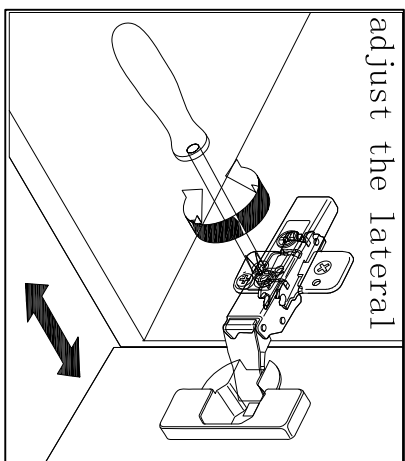
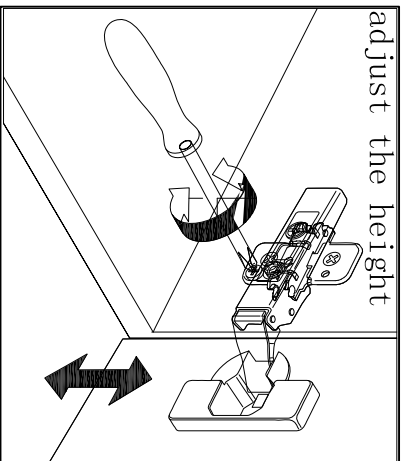

SKU : ES30036

SIZE:914x560x910

PROHIBIT COPY

